

# nexus<sup>21</sup>

CONCEALMENT SYSTEMS

**TV Lift System Model XL-75s  
Installation Instructions**

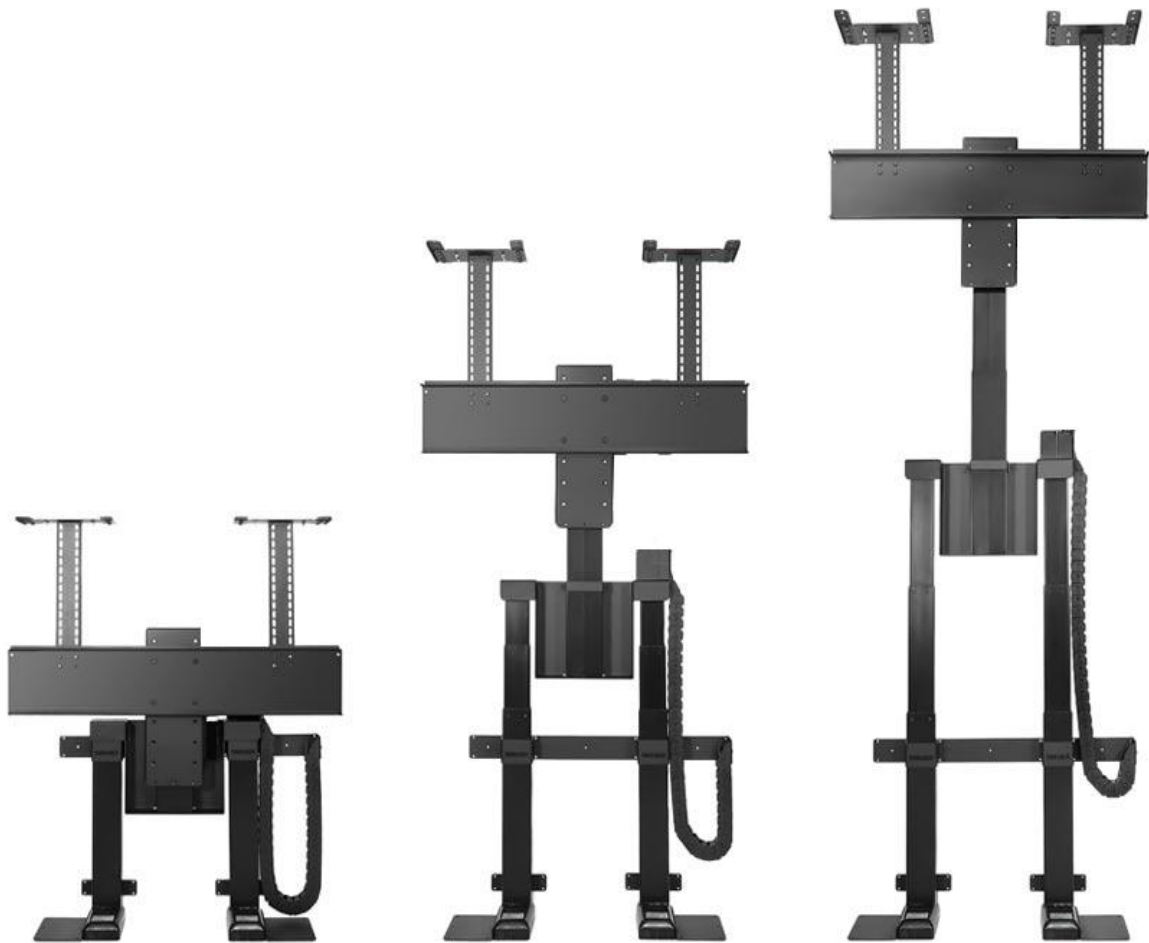

Below is a parts list describing all of the items included with the Model XL-75s Lift System.

Before beginning assembly and installation, please make sure that you have all items included on the list. If any parts are missing or damaged, please contact Nexus 21. Our contact information is shown at the top of this page.

## Parts List



Lower Lift Columns



Upper Lift Column



Screen Support



Base Plate



Upper Column Brace



Center Riser Bracket



Rear Support Bracket



Screen Back Plate



Lower Column Support



Top Plates



Lower Column Brace



Vertical Mounting Bars

## Parts List, continued



Control Box



Top Support Brackets



Cable Management Track



Assorted Hardware



Swivel Mechanism



Swivel Adapter Plate



Center Cable Management Bracket



Right Cable Management Bracket

### Cables

- **Motor Cables (3)** – Black cable with white, six-pin plugs. Use these cables to connect the Lift Columns to the Control Box (using slots #1, #2, and #3 on the Control Box). There are 3 Cables total, in 2 different sizes, 4.5m and 2.5m.
- **Power Cable** – Connects Control Box to power outlet. Three feet long.
- **RF Cable (only present if you ordered the RF version of the Lift System)** – Use to connect the RF Receiver to the Control Box. Ends have RJ-45 connectors. One foot long.

### Hardware



13. Eight (4) – 5mm x 12mm Flat Head Machine Screw
14. Six (6) – 6mm x 12mm Flat Head Machine Screw
15. Four (4) -- 6mm x 16mm Flat Head Machine Screw
16. Twelve (12) – 6mm x 20mm Flat Head Machine Screw
17. Sixteen (16) – 6mm x 10mm Button Head Machine Screw
19. Eight (8) -- 6mm x 12mm Button Head Machine Screw
20. Four (4) -- 3/8 - 16 x 3/4" Button Head Machine Screw
21. Two (2) -- Screen Locks (In bag labeled PDM-0108)
22. Four (2) -- 1 1/2" x 1/4" Steel Threaded Taper Pins (For Floating Top)
23. Two (2) -- #10 x 1 3/4" Flat Head Wood Screw (For Backup Switch)
24. Thirty-Six (36) -- #10 x 3/4" Truss Head Wood Screw
25. Two (2) -- #8 x 3/4" Flat Head Wood Screw (For IR controls only)
26. RF Controls or IR Controls (see explanation on page 5)
27. Three (3) -- Allen Wrenches –3mm, 4mm and 7/32"
28. Four (4) -- Square Multi Mount Washers
29. Four (4) – Lid Catch Brackets w/ (8) #10 x 3/4" THWS



# SAFETY INFORMATION

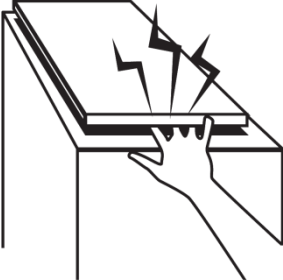

**SEVERE PERSONAL INJURY AND PROPERTY DAMAGE CAN RESULT FROM IMPROPER INSTALLATION OR ASSEMBLY.  
READ THE FOLLOWING WARNINGS BEFORE BEGINNING:**

<p><b>TV HAZARD</b></p> 	<p><b>LID HAZARD</b></p> 	<p><b>UNDER FLOOR HAZARD</b></p> 
<p><b>CAUTION:</b> Avoid contact with the TV and Lift System during operation. Use with caution.</p>	<p><b>CAUTION:</b> The lid of your enclosure must be installed as described in the instructions, using the Steel Threaded Tapered Pins. Installing the enclosure lid in any other fashion will create hazardous pinch points that can cause serious personal injury. More info on page 25 &amp; 26.</p>	<p><b>CAUTION:</b> FOR UNDER FLOOR INSTALLATIONS ONLY: Do not, under any circumstances, allow any person or pet to position themselves underneath the TV at any time.</p>

## WARNINGS:

1. Do not use this product for any application other than those specified by Nexus 21.
2. Do not exceed the weight capacity. This can result in serious personal injury or damage to the equipment. It is the installer's responsibility to ensure that the total combined weight of all attached components does not exceed that of the maximum figure stated.
3. Follow all technical specifications and instructions during the installation.
4. Only use attachments/accessories specified by the manufacturer.
5. Close supervision is necessary when this system is being used by, or near, children, or disabled persons.
6. It is the responsibility of the installer to warn all potential users of the dangers of interfering with the mechanism during operation.
7. Read all technical instructions fully before installation and use. It is the installer's responsibility to ensure that all documentation is passed on the users and read fully before operation.
8. Failure to provide adequate structural strengthening, prior to installation can result in serious personal injury or damage to the equipment. It is the installer's responsibility to ensure the structure to which the Lift System is affixed can support four times the weight of the system.
9. Risk of electric shock. Do not attempt to open the Control Box.
10. To reduce risk of fire or electric shock, do not expose parts to rain or other liquids.
11. Protect the power cord from being walked on or pinched.
12. Keep all documentation.
13. Heed all warnings.
14. Clean only with a dry cloth.
15. Refer all service questions to Nexus 21 if the system does not operate normally.

*Nexus 21 disclaims any liability for modifications, improper installations, or installations over the specified weight range. Nexus 21 will not be liable for any damages arising out of the use of, or inability to use, Nexus 21 products. Nexus 21 bears no responsibility for incidental or consequential damages. This includes, but is not limited to, any labor charges for the servicing of Nexus 21 products performed by anyone other than Nexus 21.*

*Nexus 21 intends to make this and all documentation as accurate as possible. However, Nexus 21 makes no claim that the information contained herein covers all details, conditions or variations, nor does it provide for every possible contingency in connection with the installation or use of this product. The information contained in this document is subject to change without prior notice or obligation of any kind. Nexus 21 makes no representation of warranty, expressed or implied, regarding the information contained herein. Nexus 21 assumes no responsibility for accuracy, completeness or sufficiency of the information contained in this document.*

## Types of Controls for Nexus 21 Lift Systems

All Nexus 21 Lift Systems come standard with a **wireless remote control** and receiver. We offer a choice of two different types of remotes: IR and RF (both of which are explained in detail below). Our standard control type is RF, so unless you specifically requested the IR version when you made your purchase, you probably received the RF controls with this Lift System. The method of installation for each type of remote control is slightly different, so you should now identify which type of remote you have by reading below, and then follow the instructions for that type of remote.

**NOTE:** If you will be using the Lift with a home control system (like the ones made by companies such as Crestron or Control 4) the most common form of control is to WIRE IT DIRECTLY to the relays of your home control system. This direct-wire method is called **Integration by Contact Closure**, and is accomplished by using the Contact Closure Hardware that is supplied with the IR Control Kit to connect the Lift to your home control system.

### Before You Begin the Installation: Identify Your Control Type

**IR (Infrared)** – This control option allows you to utilize a 3<sup>rd</sup> party universal style remote control to raise and lower the TV Lift. Your universal remote will “learn” the IR codes from the provided IR Handset, which will enable you to control the lift. The universal remote will then communicate with the “eye” located on the IR Receiver via your 3<sup>rd</sup> party emitter (or flasher). Instructions for setting the TV Lift’s travel limit are on Page 30.

**NOTE:** If you are NOT planning on using a 3<sup>rd</sup> party Universal Remote, switch to the RF setup. (There is no charge for swapping)

**These are the parts included with IR controls:**



Contact Closure Hardware



IR Receiver



IR Handset



Height Limit Insert

**RF (Radio Frequency)** - This system utilizes a wireless remote control handset that sends a radio signal to the RF Receiver. The radio signal can go through cabinet walls and does not require line-of-sight. Instructions for setting the Lift System travel limit are on Page 30.

**TIP:** Planning to integrate the TV Lift with your UNIVERSAL REMOTE CONTROL? The RF version of the Nexus 21 controls won't do it. Switch to IR.

**These are the parts included with RF controls:**



Backup Switch



RF Receiver



RF Handset



Height Limit Insert

**Integration by Contact Closure** – To direct-wire the TV Lift controls to a home control system (Crestron, Control 4, AMX, etc.) you will use the Contact Closure Hardware. You won't use any Nexus 21 receiver or handset for this type of control because you will use the handset or control pad that comes with your home control system. **Instructions for setting up the System using Contact Closure are on “Page 31”.**

## Assembly and Mounting – Things to Think About First



### **SAFETY NOTICE:**

- For proper support, the Lift System **MUST NOT** be attached to any material that is less than ¼” thick. This applies to BOTH the back and bottom mounting points.
- The Lift Column is **ONLY** designed and rated for **VERTICAL, NON-INVERTED USE. DO NOT MOUNT THIS LIFT SYSTEM UPSIDE DOWN or SIDEWAYS (HORIZONTALLY)!**

**TIP:** Inverted (drop-down) lift systems are available from Nexus 21. Contact Customer Service at (866) 500-5438.

### **Space requirements for the XL-75s Lift System are as follows:**

Depth= TV Depth + 6.85” or a minimum of 9.75”, whichever is greater.

Height = TV Height + 2”, or a minimum of 46”, whichever is greater.

Width= TV Width + 2”



**IMPORTANT NOTE:** The Lift System must be mounted **as high up as possible inside the cabinet**, so that when the Lift is in the fully “DOWN” position (fully retracted), the top of the TV will be just underneath the lid of the cabinet. A 1/8” gap between the lid and the Top Plate is ideal.

### **Lift System height and mounting position:**

The Top Support Brackets allow you to adjust the installation height of the Lift in ¼” increments if necessary. When fully assembled in the standard configuration, the HEIGHT of the Lift will be a minimum of 45.8” up to a maximum of 53.8” with the Top Support Brackets in the highest position. See installation dimensions diagram on following page.

## About the Cabinet Lid (Cabinet Top)



### **SAFETY NOTICE:**

**WARNING! YOU MUST NOT DIRECTLY SCREW THE CABINET LID (TOP) TO THE LIFT SYSTEM!! THIS CREATES HAZARDOUS “PINCH POINTS” AND MAY AFFECT THE OPERATION OF THE LIFT OR CAUSE DAMAGE TO THE CABINET TOP.** For floating lids, **DO NOT USE SCREWS to attach the lid to the Lift System.** Instead, use the “Threaded Taper Pins”. This will keep the lid firmly in place, but will also allow it to **separate from the lift system** if anything (like a finger) gets in the way when the TV lowers.

### **Which Lid Style Will You Use? (There are 2 Different Styles)- Hinged Lid Compatible**

**Floating Lid (Floating Top)** – The whole top of the cabinet sits on top of the Lift System and raises/lowers with the TV. This is the standard Installation method, using the Top Plate and Threaded Tapered Pins.

**Cut-Out Floating Lid (Top)** – You will “cut out” part of your cabinet top, customizing it to the size of your TV. That cut-out lid then sits on top of the Lift System and raises/lowers with the TV. This method uses the Top Plate and Threaded Taper Pins, but you must set up a “catch” for the cut-out lid so that when the TV lowers, the lid stops level with the rest of your cabinet top (like a manhole cover).

# [Table of Contents](#)

The entire Lift System consists of three major systems: the Actuation System, Cable Management System and the TV Mounting System. This instruction manual will cover how to build, install and connect the Lift.

## 1) [Building the Lift System](#)

- i) Lower Actuation Assembly
- ii) Lower Support Assembly
- iii) Installing the Lift Columns into your Cabinet
- iv) Upper Actuation Assembly
- a) Assembling the Actuation System
- b) Assembling the Cable Management System
- c) Assembling the TV Mounting System

## 2) [Connecting the Lift](#)

## 3) [Mounting the TV to the Lift](#)

## 4) [Creating a Floating Lid](#)

- a) Threaded Tapered Pins
- b) Lid Catches

## 5) [Lift Adjustability Points](#)

## 6) [Dimensional Drawing](#)

## 7) [Reference Guide](#)

- a) Setting the Height Limit
- b) Common Procedures

## 8) [Control System Integration](#)

# Building the Lift System

## Lower Actuation Assembly



For these steps you will need the following parts:

- (2) Lower Lift Columns
- (2) Base Plates
- (2) Lower Column Supports
- (8) 6 x 10 mm BHMS Screw
- Small Hex Key

**Step 1:** Attach (1) *Base Plate* to the *Lower Lift Column* using (2) *6 x 10 mm BHMS screws*. Refer to picture 1.

**Step 2:** Attached (1) *Lower Column Supports* to the *Lower Lift Column* using (2) *6 x 10 BHMS screws*. Refer to picture 2.

**Step 3:** Repeat steps 1 and 2 for the second column, this time attaching the *Base Plate* to the alternate side.

**Step 4:** The Lower Actuation Assembly is now complete.





## Lower Support Bracket Assembly

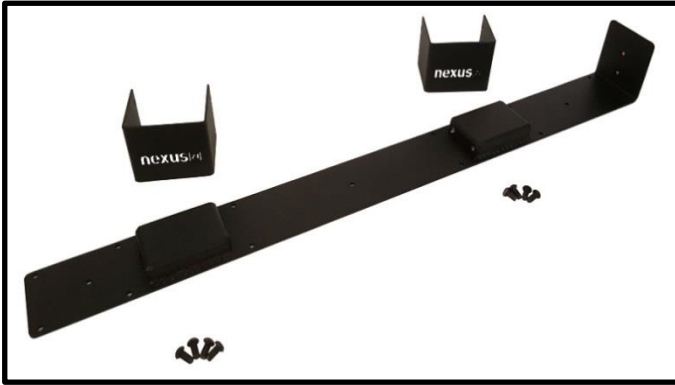

**For these steps you will need the following parts:**

- (2) Lower Column Brace
- Rear Support Bracket
- (8) 6 x 12 mm BHMS Screws
- Small Hex Key

**Step 5:** Place the *Lower Column Braces* over the raised segments of the *Rear Support Bracket* to match picture 5.

**Step 6:** Attach the (2) *Lower Column Braces* to the *Rear Support Bracket* using (8) 6x 12 mm BHMS Screws. Leave the outer screws slightly loose for adjustment in the steps for "**Assembling the Actuation System**". Refer to picture 6.

**Step 7:** The Lower Support Bracket Assembly is now complete.



## Installing the Lift into your Cabinet



For these steps you will need the following parts:

- Lower Actuation System
- Lower Support Bracket Assembly
- (35) 10 x 3/4" THWS Screws
- Your Cabinet
- Phillips Drill Bit & Drill

**Step 8:** Place the Lower Support Bracket over the Lower Actuation System. Ensure the Nexus 21 Logo is not upside down and the 90 degree bend is on the right hand side.



**Step 9:** Place the Lower Actuation System with the Lower Support Bracket into your cabinet.

**Step 10:** Adjust the Lower Support Bracket so that it sits right below the 2 small circles on each of the Lift Columns.

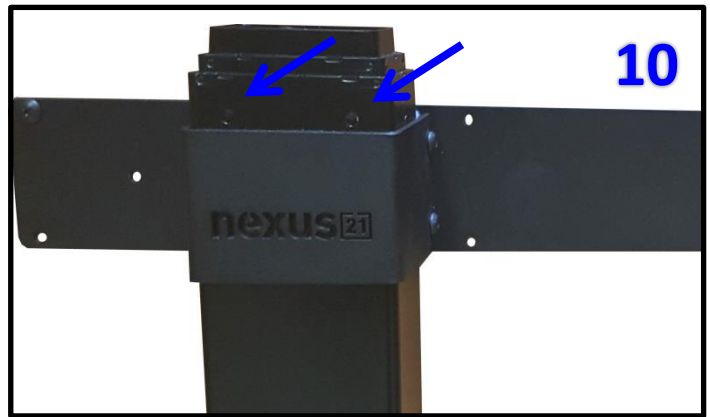

**Step 11:** Center the Lift horizontally in your cabinet and mount the Lower Column Support and Base Plate for each column to the cabinet using (20) 10 x 3/4" THWS Screws.

**Step 12:** Repeat Step 10 if necessary and mount the Lower Support Bracket Assembly to the rear wall of the cabinet using (15) 10 x 3/4" THWS Screws.



## Upper Actuation Assembly



For these steps you will need the following parts:

- Upper Lift Column
- Center Riser Bracket
- Upper Column Brace
- (2) 6 x 12 FHMS Screws
- (4) 6 x 20 mm FHMS
- Small Hex Key

**Step 13:** Attach the *Upper Lift Column* to the *Center Riser Bracket* using (4) 6 x 20 mm FHMS Screws. Ensure that the pigtail cable for the *Upper Lift Column* is facing the interior of the *Center Riser Bracket*. Refer to picture 13.

**Step 14:** Attach the *Upper Column Brace* to the *Center Riser Bracket* using (2) 6 x 12 mm FHMS. Refer to picture 14.

**Step 15:** The Upper Actuation Assembly is now complete.



## Assembling the Actuation System

### For these steps you will need the following parts:

- Lower Actuation Assembly with Lower Support Bracket already installed in the Cabinet.
- Right Cable Management Bracket
- Upper Actuation Assembly
- Swivel Mechanism
- (8) 6 x 20 mm FHMS Screws
- Small Hex Key

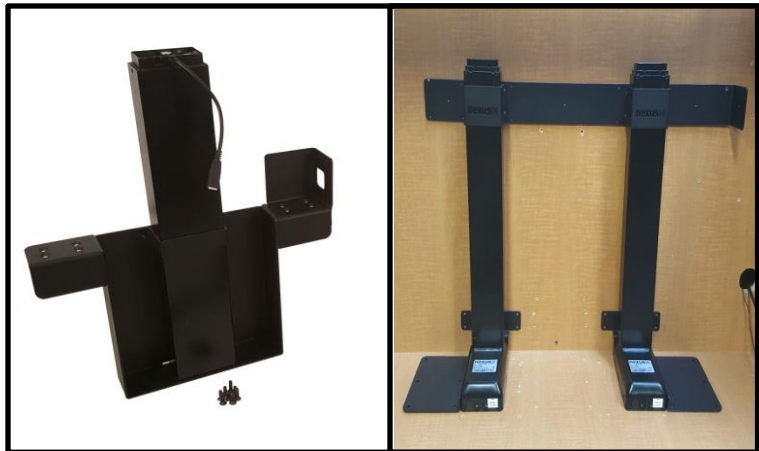

**Step 16:** Place the *Upper Actuation Assembly* onto the *Lower Actuation Assembly*. You may need to support the Upper Actuation Assembly until you fasten it to the Lower Actuation Assembly. See photo to the left for reference.

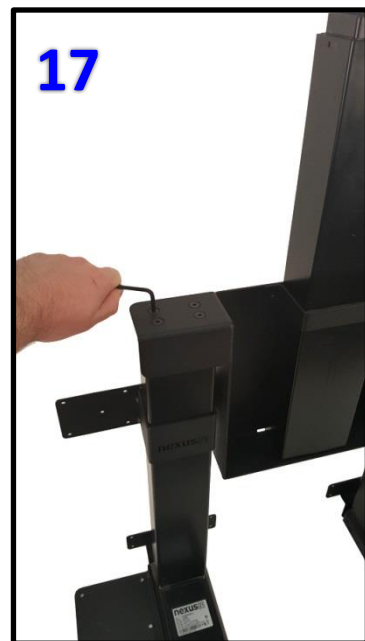

**Step 17:** Fasten the left side of the *Upper Actuation Assembly* to the *Lower Actuation Assembly* using (4) 6 x 20 FHMS Screws. See photo to the right for reference.

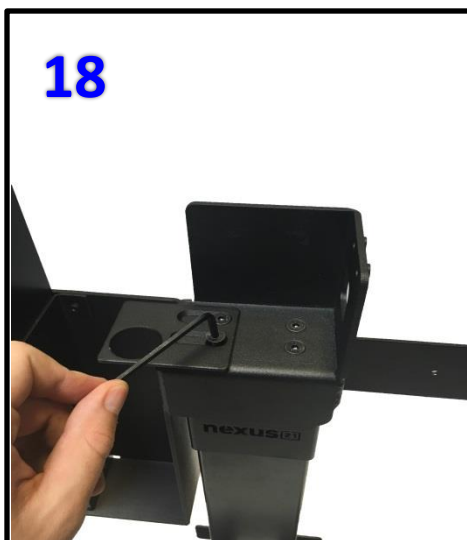

**Step 18:** Fasten the Center Riser Bracket to the Lower Actuation Assembly, then place the Right Cable Management Bracket over the first set of holes on the right side of the Upper Actuation Assembly and fasten them together using (2) 6 x 20 FHMS Screws leaving the screws slight loose. See photo to left for reference.

**Step 19:** Separate the Swivel Mechanism from the Swivel Adapter Plate and attach the Swivel Adapter Plate to the top of the Center Lift Column using (4) 6 x 12 BHMS Screws.



**Step 20:** Re-Attach the Swivel Mechanism to the Swivel Adapter Plate and fasten them together by tightening the screws in the unthreaded holes on the top of the Swivel.

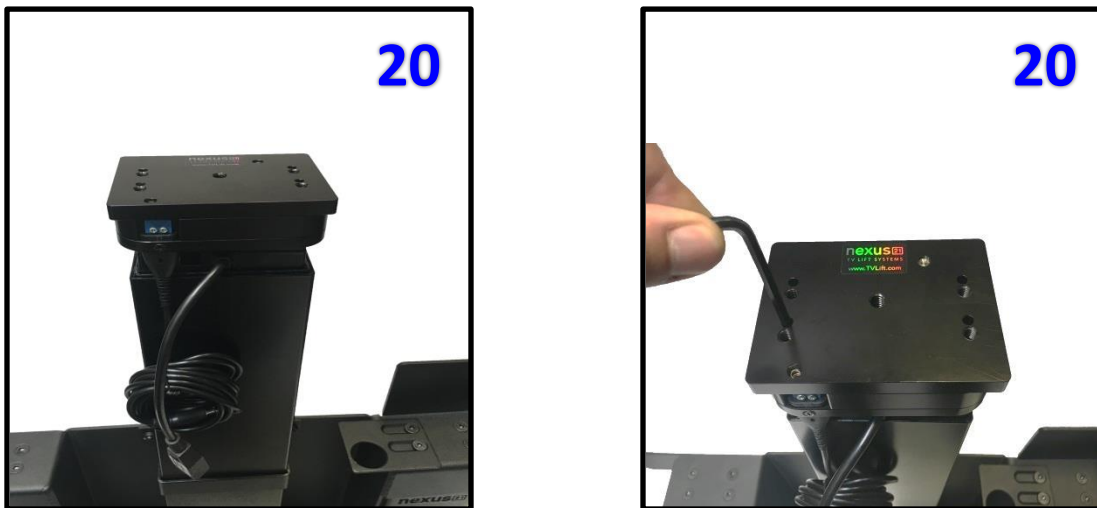

# Assembling the Cable Management System



For these steps you will need the following parts:

- Cable Management Track
- Screen Support
- Actuation System
- (4) 5 x 12 mm FHMS Screws
- (4) 6 x 10 mm BHMS Screws
- 4.5m Motor Cable
- 6' Adapter Cable
- Small Hex Key
- 3 mm Hex Key
- Snakeskin Wrap

**Step 21:** Attach the Cable Management Track to the Center Riser Bracket using (2) 5 x 12mm FHMS Screws.



**Step 22:** Connect the 4.5m Motor Cable to the Center Lift Column.

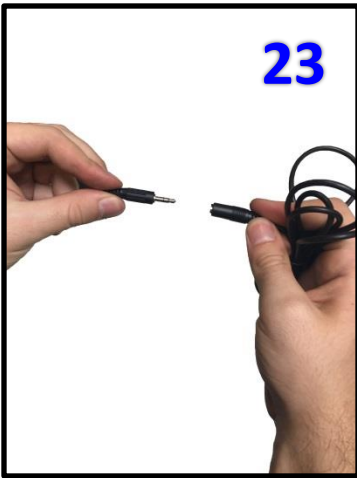

**Step 23:** Connect the Swivel Cable coming off of the Swivel Mechanism to the 6' Adapter Cable.

**Step 24:** Feed Both the Swivel Cable and 4.5m Motor Cable up through the Right Cable Management Bracket, through the Slot in the Center Riser Bracket, and down through the Cable Management Track.



**Step 25:** Feed both the Swivel Cable and 4.5m Motor Cable through the Cable Management Track until the cables rest equal to the Lower Support Brackets.

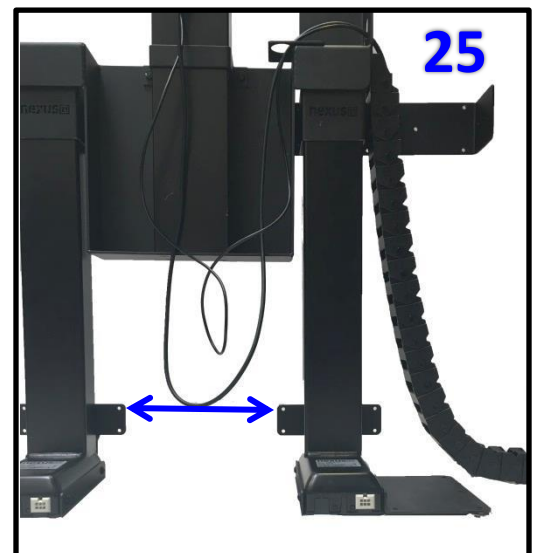



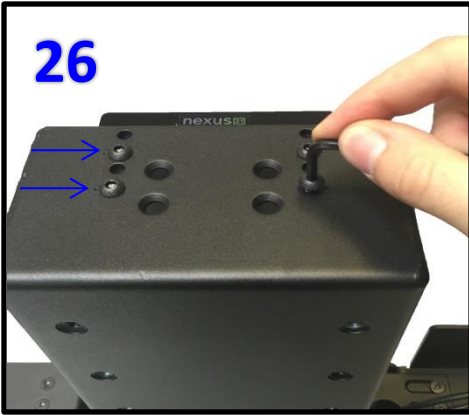

**Step 26:** Line up the “dotted” holes on the Screen Support Bracket with the “threaded” holes on the Swivel Mechanism and it using (4) 6 x 10 BHMS Screws.

**Step 27:** Starting from the bottom of the Screen Support Bracket, use the Snakeskin Wrap to wrap the Swivel Cable and 4.5m Motor Cable, leaving the loop between the Lower Lift Columns.

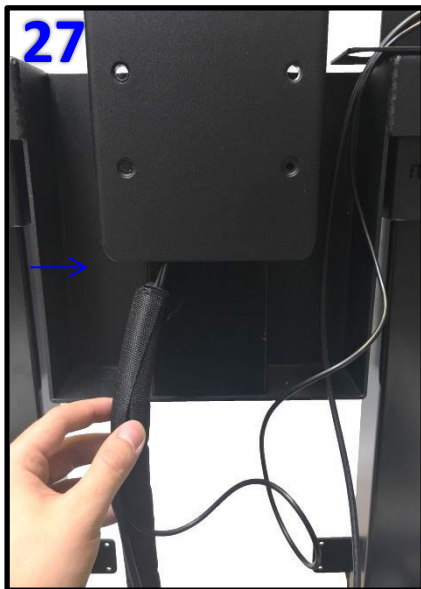

**Step 28:** Push the Snakeskin Wrap up through the Right Cable Management Bracket, slide Right Cable Management Bracket to the right the pin the cables against the Center Riser Bracket, and tighten the (2) 6 x 20 FHMS Screws.



**Step 29:** Attach the right half of the Cable Management Track to the Rear Support Bracket using (2) 5 x 12 mm FHMS Screws.

You have successfully installed the Cable Management System.

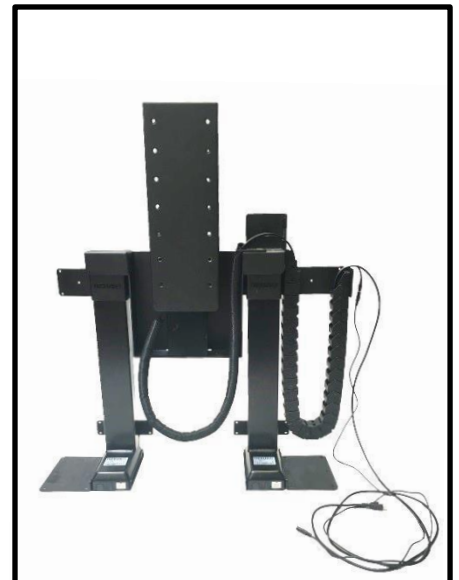

## Assembling the TV Mounting System



**For these steps you will need the following parts:**

- Actuation System
- (2) Top Support Brackets
- (2) Top Plates
- Screen Back Plate
- Center Cable Management Bracket
- (4) 6 x 12 mm FHMS Screws
- (4) 3/8" x 16 BHMS Screws
- (8) 6 x 12 mm BHMS Screws
- Small Hex Key
- Large Hex Key

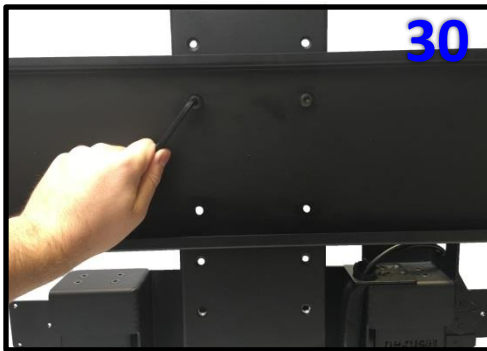

**Step 30:** Attach the *Screen Back Plate* to the *Actuation Assembly* using (2) 3/8" x 16 BHMS Screws. Mount the *Screen Back Plate* using the 4 holes towards the middle of the *Screen Support* for now as adjustments will be covered in the "**Adjustments**" section of the Instruction Manual on page (28).

**Step 31:** Using the remaining (2) holes on the *Screen Back Plate*, attach the *Center Cable Management Bracket* using (2) 3/8" x 16 BHMS Screws. Ensure the larger hole in the bracket is face down and to the left. See photo to right for reference.

**Note:** The *Center Cable Management Bracket* allows management of all of the TV Cables in one bunch using the larger hole. The smaller holes act as anchors for zip ties allowing for further cable management.





**Step 32:** Attach both of the *Top Plates* to the top of the *Top Support Brackets* using (4) 6 x 12 FHMS Screws. Ensure that wings of the *Top Plate* are pointing towards the front of the Lift System. See photo to the left for reference.

**Step 33:** Attach both of the *Top Plates* to the top of the *Top Support Brackets* using (4) 6 x 12 FHMS Screws. Ensure that wings of the *Top Plate* are pointing towards the front of the Lift System. See photo to the left for reference.



You have successfully installed the TV Mounting System.

## Connecting the Lift System

**Step 34:** Using the XL-75s IR Wiring Diagram below, connect the cables for your Lift System with IR Controls.

**Note:** If you have RF Controls please see the next page for the XL-75s RF Wiring Diagram.

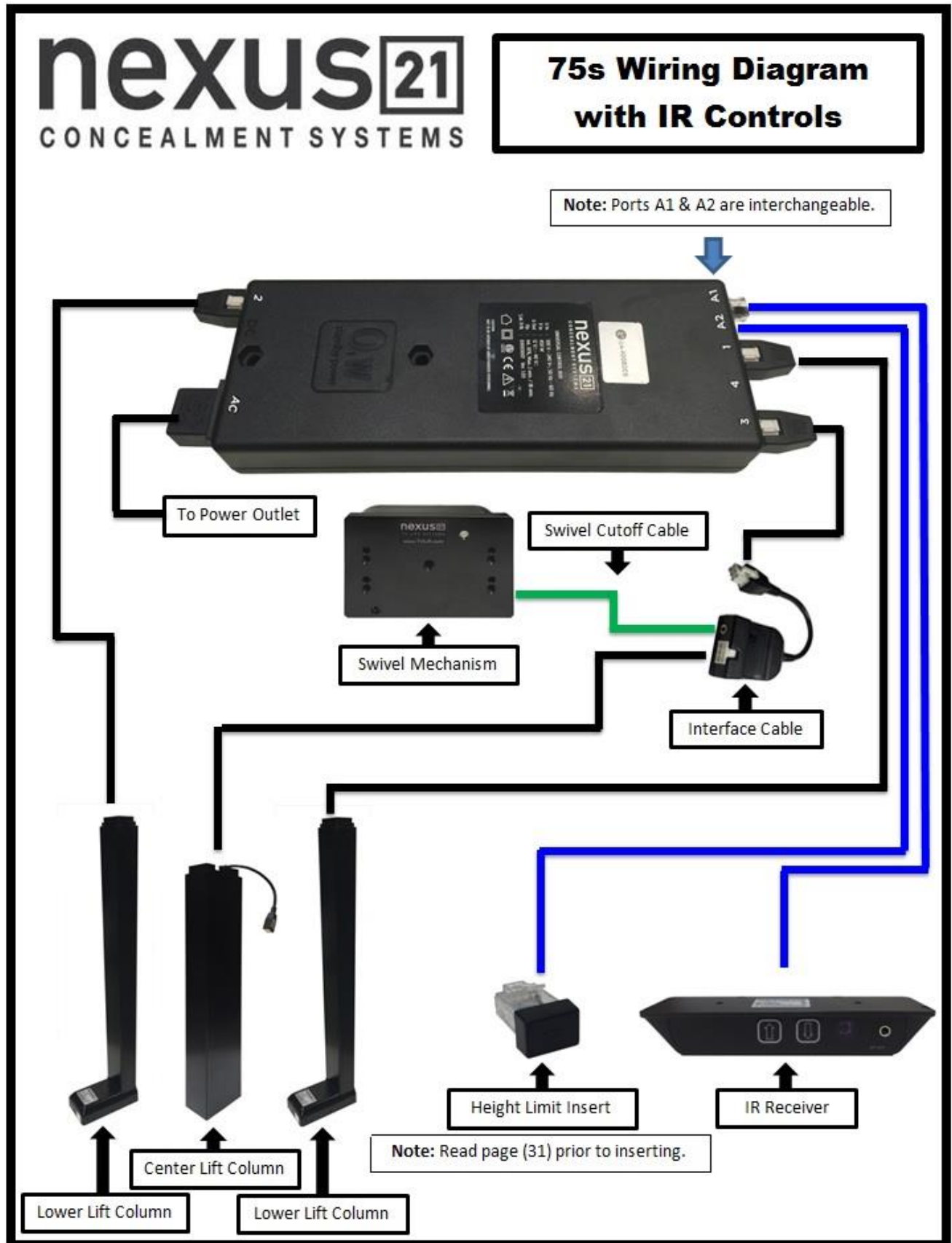

**Step 34 Continued:** Use this XL-75s RF Wiring Diagram if you have RF Controls.

**Note:** If you have IR Controls refer to the previous page.

**nexus<sup>21</sup>**  
CONCEALMENT SYSTEMS

**75s Wiring Diagram  
with RF Controls**

Note: Ports A1 & A2 are interchangeable.

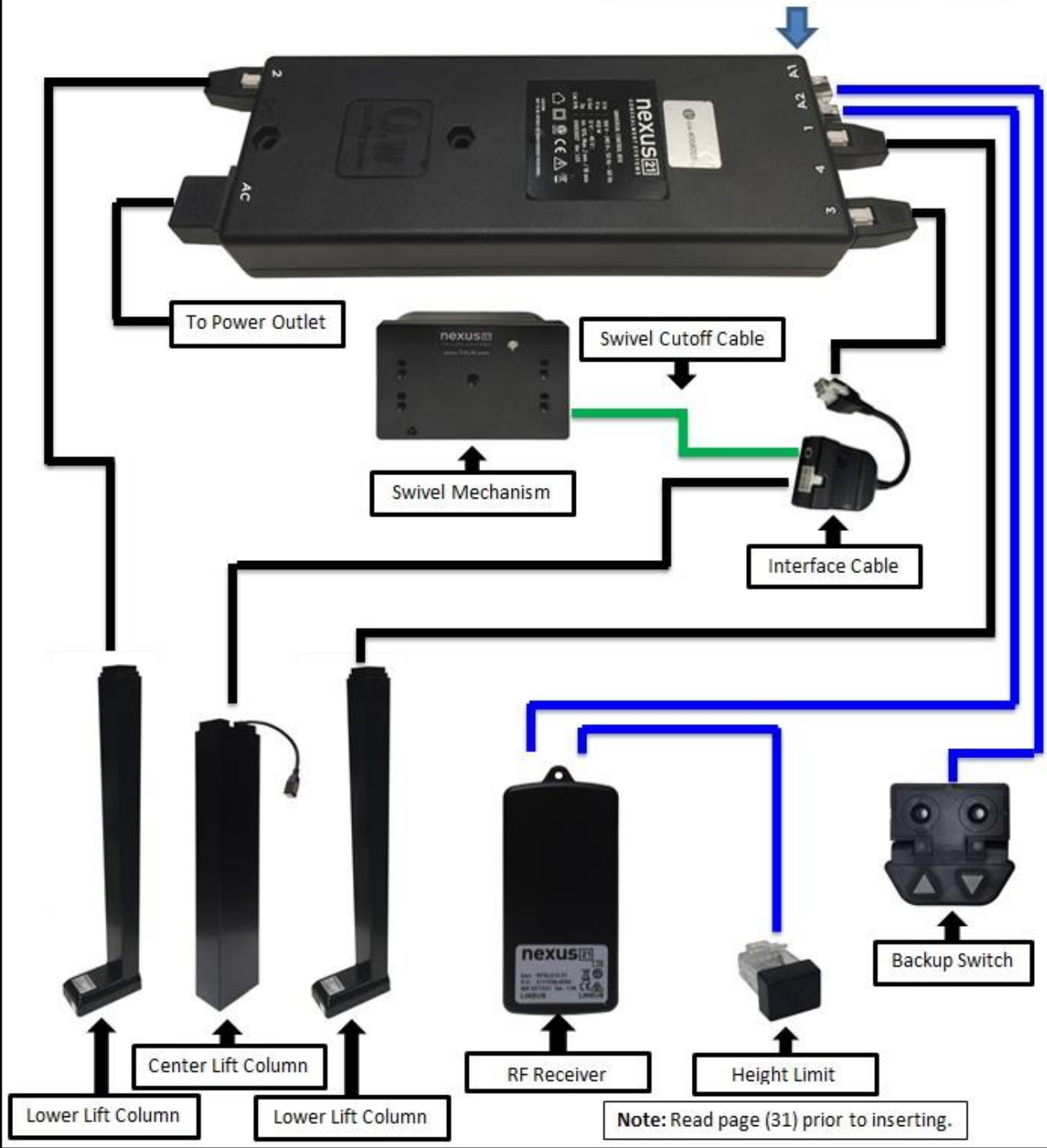

**\*\*\*\*\*IMPORTANT\*\*\*\*\***

**Step 35:** Once you have connected the controls, test the Lift Column as follows:

1. First, you need to “initialize” the Lift System. If you have already raised the Lift Column, lower it again, since this step must be performed in the “down” position.
2. Find the Wired Backup Switch, which has two triangle-shaped buttons - an UP (with raised dot) and a DOWN.
3. Press the DOWN button and HOLD IT DOWN for approximately 5 seconds.
4. You should see a slight movement in the Lift Column. If you do not see the movement, release the Down button, and repeat the process - press and hold the Down button again for 5 seconds.
5. Once you have seen the slight movement, the Lift System is now functional.
6. Test it by pressing the Up button (no need to hold the Up button) and the lift will go up. You may let it go to the top, or stop it at any time by pressing the Down button.

## Mounting the TV to the Lift



**Step 36:** Attach the Vertical Mounting Bars to the TV using the screws found in the bag labeled “TV Mounting Screws/Spacers.” The length and size of the screw required will depend on whether the TV has a flat/unobstructed or irregular/obstructed back.

### A

Flat/Unobstructed Back

Diagram “A” installation procedure:

- 1) Place the flat screen TV face down on a protected surface.
- 2) Position the Vertical Mounting Bars equidistant from the bottom and top of the TV, with the slots facing toward the top of the TV.

- 3) Using the four (4) Square Multi-Mount washers and the TV mounting screws selected from the bag, attach and tighten the hardware.

**DO NOT OVERTIGHTEN HARDWARE. DAMAGE TO TV MAY RESULT.**

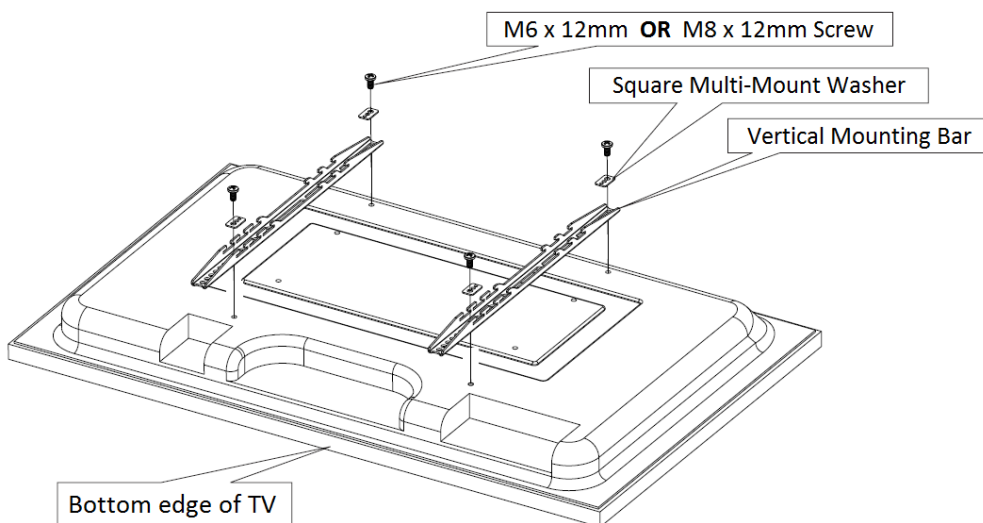

### B

Irregular/Obstructed Back

Diagram “B” installation procedure:

- 1) Place the flat screen TV face down on a protected surface.
- 2) Position the Vertical Mounting Bars equidistant from the bottom and top of the TV, with the slots facing toward the top of the TV.

- 3) Using the four (4) spacers needed, (4) Square Multi-Mount washers and the TV mounting screws selected from the bag, attach and tighten the hardware.

The hardware will be used in this order (as shown in the diagram above):

TV, Spacers, Vertical Mounting Bars, Square Multi-Mount Washers, TV Mounting Screws.

**DO NOT OVERTIGHTEN HARDWARE. DAMAGE TO TV MAY RESULT.**

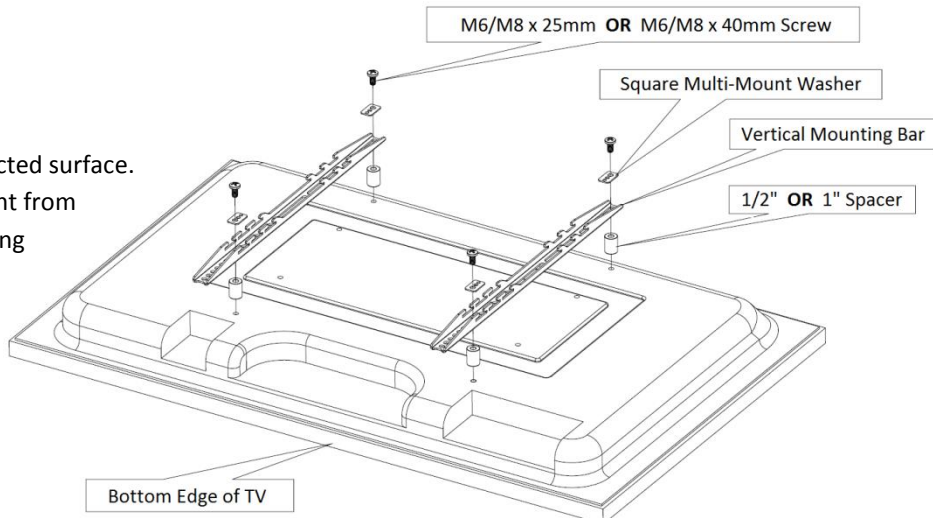



**Step 37:** Mount the TV to the front of the lift system by hanging the TV on the *Screen Back Plate*. DO NOT use the outside slot.



**Step 38:** Insert both *Screen Locks* into both *Vertical Mounting Bars*. Using (2) *Screen Locks*, place one *Screen Lock* on the bottom set of hooks for each *Vertical Mounting Bar*. Using a Philips Head Screwdriver (not provided), tighten the *Screen Locks* against the bottom of the *Screen Back Plate*. This will ensure the TV does not slide left to right and eliminate the TV from being lifted off of the mount.



## Attaching the Floating Lid

**Step 39:** Fully retract the lift and place the Cabinet Lid onto the Top Plates so that it is centered in the cabinet opening.

**Step 40:** Run the Lift up using the IR or RF Controls and then back down. Make sure that when the lift comes down, the Cabinet Lid drops into a centered position within the cabinet opening.

**NOTE:** You may temporarily tape your lid in place to prevent any shifting if needed.

**Step 41:** Run the lift all the way up, making sure the lid does not move out of place and locate “nesting holes” for each top plate. See photo to right for reference. Using a pencil or felt tipped pen, mark the position of each of the holes on the underside of the cabinet lid.

**NOTE:** Make sure the nuts on the bottom side of the Top Plates are hand tight and centered before you mark your lid. You may use the 2 outer holes or all 4 holes.



**Step 42:** Remove Cabinet Lid and drill two holes in the marked positions using a 7/32” drill bit, 1/2” deep, in the underside of the Cabinet Lid.

**Tip:** You can wrap tape around the bit, 1/2” deep to ensure you don’t go too far into the lid.

**Tip:** If you have a granite, marble or quartz lid, you can put a wood sub decking below and then drill into that.



**Step 43:** Using a Phillips head screw driver (not provided) screw each Tapered Pin into the holes drilled in step 16.

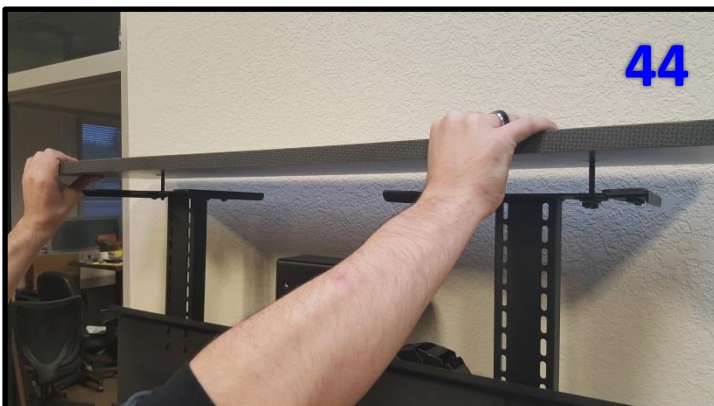

**Step 44:** Align the Tapered Pins with the holes you marked in Step 41 on the Top Plate and put the Lid on. Tighten the nuts on the underside of the hole where the Tapered Pins pass through the Top Plate.

**NOTE:** The nests on the floating lid allow for up to 1/4” of tapered pin misalignment. Before you tighten down the nests, make sure your lid aligns perfectly with the cabinet opening and floats freely for safety.

## Installing the Tapered Pins in the Floating Lid

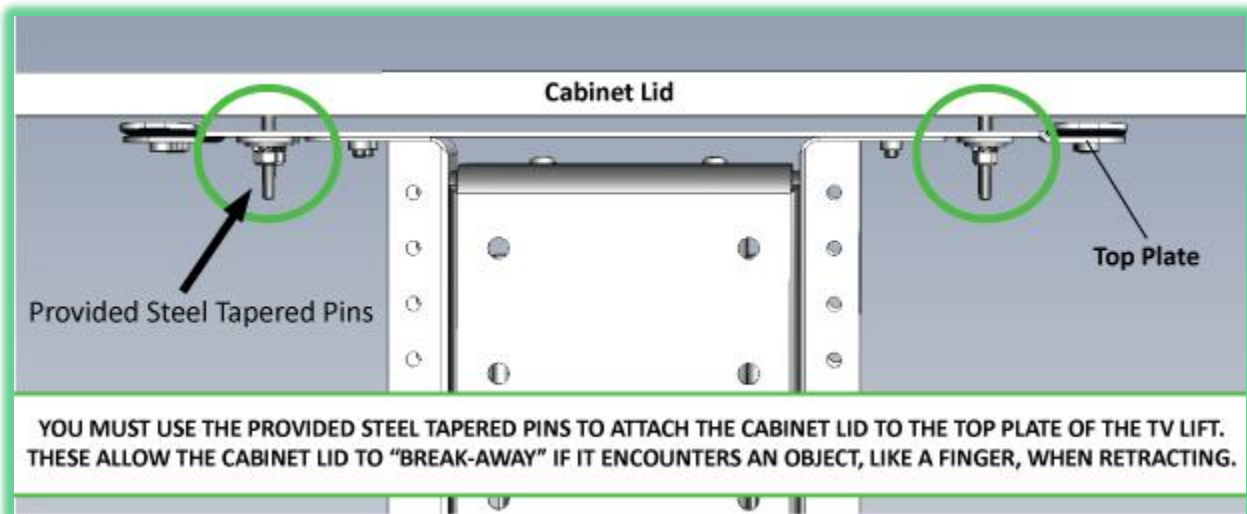

### What Are the Tapered Pins, and Why Use Them?

The two 1½" x ¼" Steel Threaded Tapered Pins are used IN PLACE OF SCREWS to hold your cabinet top (lid) in place on the Lift System Top Plate (Part #8). The Tapered Pins will keep your lid firmly in place, but will also allow it to **separate from the lift system** if anything (like a finger) gets in the way when the TV lowers. [See Safety Notice above. Please do NOT use screws with your cabinet lid.](#)

### Before You Install the Tapered Pins, Here is a Reminder of the Two Types of Floating Lids (Floating Tops):

**Floating Lid (Floating Top)** – The whole top of the cabinet sits on top of the Lift System and raises/lowers with the TV.

**Cut-Out Floating Lid (Top)** – This option assumes that you have "cut out" part of your cabinet top, customizing it to the size of your TV. That cut-out lid then sits on the Top Plate of the Lift System, held in place by the Taper Pins, and raises/lowers with the TV. You must set up a "catch" for the Cut-Out Lid so that when the TV lowers, the Lid stops level with the rest of your cabinet top (like a manhole cover), and the Lift System continues down a little further into the cabinet (no more than ¼" to ½"). In this way, when the Lift System is fully retracted, the Cut-Out Lid will always be level, and the Top Plate of the Lift System will always be positioned just below the Lid. Since the Lid and the Top Plate are slightly separated from one another, but still very close, the Taper Pins (which are 1½" long) will still be hanging down through the holes in the Top Plate so when the Lift System moves, everything is properly aligned and the Lid rides smoothly up and down.

## How to Properly Install a Lid “Catch” with a Nexus 21 Lift System

There are multiple ways to properly create a “catch” for the lid to rest on, when the lift is in the fully retracted position.

Down below are a few examples. Using the provided Lid Catch Brackets with (8) #10 x ¾” THWS attach the brackets to each corner of the lid opening. This will provide a support point for the lid to rest on while the lift is in the fully retracted position, assuring the lid is flush with the rest of the cabinetry every time.

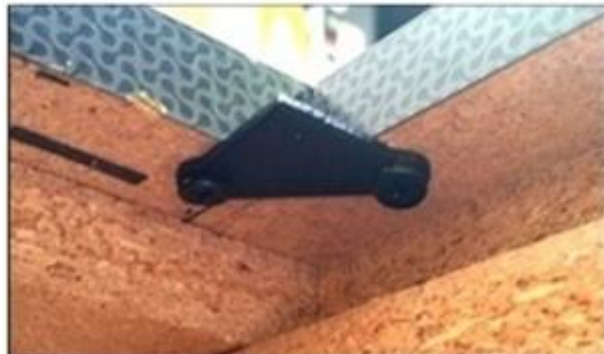

Here are a few other examples on how to create a “catch” or “lip” for the cabinet lid to rest upon.

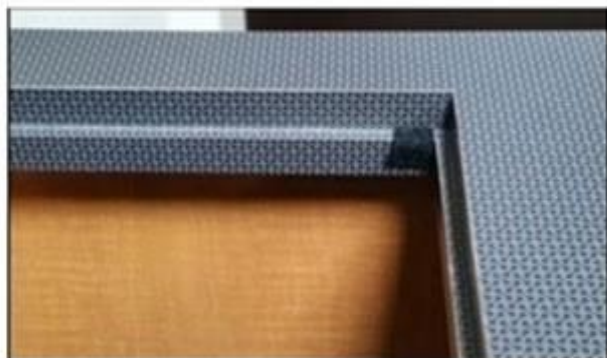

## Adjustments

The Top Support Brackets bolt to the back of the Screen Back Plate and have slotted holes that allow you to adjust the installation height of the Lift in  $\frac{1}{4}$ " increments.

**Note:** You must use all four bolt holes on the Screen Back Plate when adjusting the Top Support Brackets.

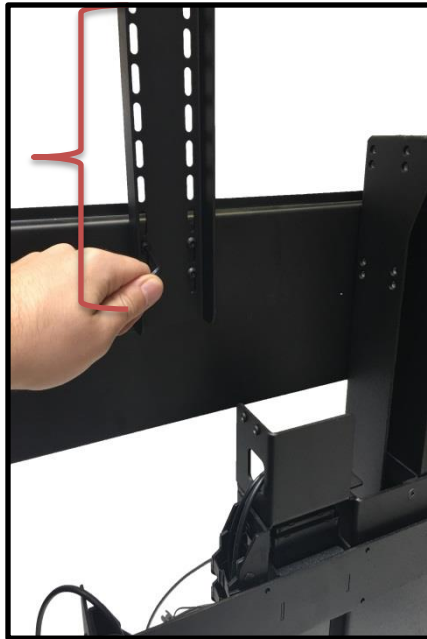

You can move the Screen Back Plate up and down, along the Screen Support to raise and lower the position of the TV on the lift. See photo to the left for reference.

**Note:** If you lower the Screen Back Plate You will need to adjust the Top Support Brackets, so that they do not hit the Upper Cable Management Track.

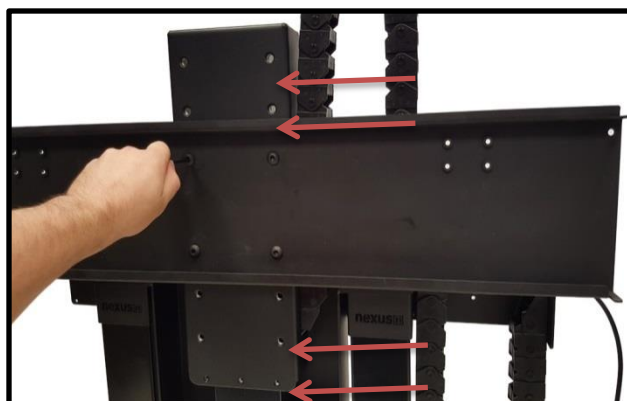

# MODEL XL-75S DIAGRAM

ALL CALCULATIONS  
ASSUME 3/4" MATERIAL  
FOR THE LID

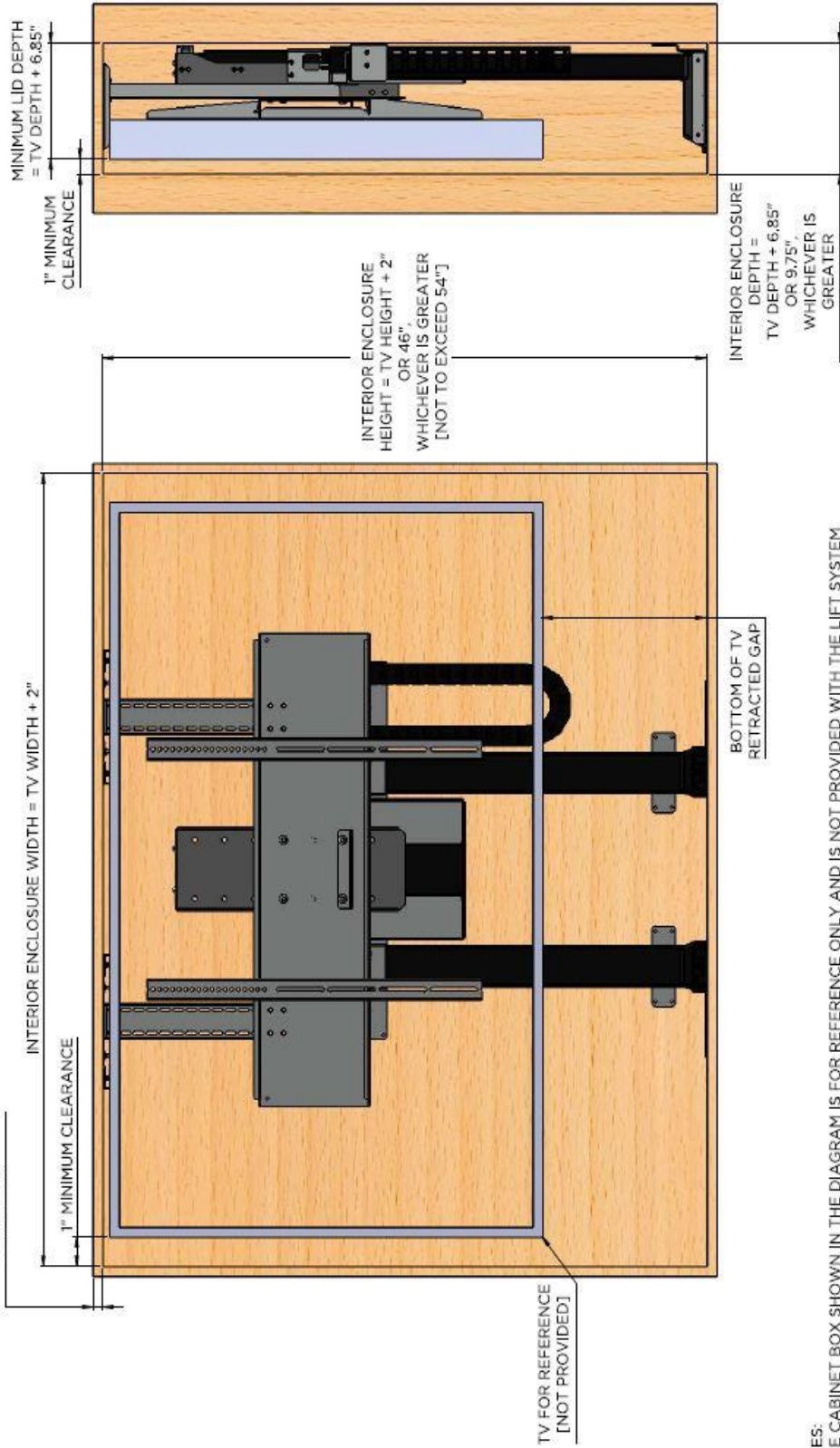

## NOTES:

1. THE CABINET BOX SHOWN IN THE DIAGRAM IS FOR REFERENCE ONLY AND IS NOT PROVIDED WITH THE LIFT SYSTEM
2. FOR THIS LIFT MODEL, THE LENGTH OF ITS TRAVEL [EXTENSION LENGTH OR STROKE] IS 64"
3. FOR THIS LIFT MODEL, THE TOTAL WEIGHT CAPACITY IS 130 LBS
4. THIS LIFT MODEL MANUALLY ROTATES 180° IN BOTH DIRECTIONS WITH A LOCKING HOME POSITION
5. LIFT WILL NOT OPERATE WHEN SWIVELED
6. HEIGHT OF THIS MODEL IS ADJUSTABLE IN 1/4" INCREMENTS UP TO 8" [MINIMUM HEIGHT = 45.8"; MAXIMUM HEIGHT = 53.8"]
7. LID IS DESIGNED TO FLOAT WITH PROVIDED TAPERED PINS - LID MUST BE REMOVEABLE FOR SAFETY
8. WHEN INSTALLED IN THE FLOOR, THE LID MUST BE SUPPORTED BY CATCHES
9. THE LIFT MUST BE FASTENED TO THE FLOOR AND REAR WALL OF THE ENCLOSURE FOR OPTIMAL STABILITY AND SAFETY
10. WHEN DETERMINING TV HEIGHT, ALWAYS USE MANUFACTURER SUPPLIED "TV WITHOUT STAND" HEIGHT
11. LIFT MECHANISM IS POWDERCOATED BLACK STEEL, COLORS IN DIAGRAM ARE FOR CLARITY ONLY.

**nexus21**  
CONCEALMENT SYSTEMS

COPYRIGHT 2016 • ALL RIGHTS RESERVED  
UPDATED 07/01/16

## Reference Guide

### Lift Components:



Wired Backup  
Switch



Height Limit  
Insert



Control Box



IR Receiver



Motor Cable



RF Receiver

## Setting your Height Limit

### **Setting the Height Limit for IR and RF:**

1. Simply extend the lift to your desired height using *IR Receiver* or *Wired Backup Switch* and tap the down button to stop the lift at that height.
2. Then put the *Height Limit Insert* into either port A1 or A2 on the *Control Box*.
3. Your remote will now obey the height limit you have set.

## Common Procedures:

### **Reinitialize:**

1. Fully retract the lift;
2. Once the lift is fully retracted, press and hold the down button on either the *Wired Backup Switch* or *IR Receiver* for about 5-10 seconds. You should see a slight movement from the lift system.
  - a. **Note:** If you do not see the movement on the first attempt, release the down button and try these steps again. It may take 2 or 3 tries.

### **Resetting the Lift from Safe Mode (Safe Mode occurs when power is lost while the lift is extended):**

1. The lift will only retract and it moves at half the speed.
2. Press and hold the down button until the lift fully retracts.
3. Then follow the steps to Reinitialize the lift.

### **Pairing your RF Remote:**

1. Locate the pinhole on the side of the *RF Receiver*.
2. Using a paper clip, press and hold the button inside the pin hole and the down button on the *RF Remote* at the same time. Keep them both held for 5 seconds.
  - a. **Note:** The paper clip should only go a short distance into the *RF Receiver* to press the button. If your paper clip goes all the way in, reposition it and try again.
3. Release both buttons and try using your *RF Remote* again.
4. If the remote does not respond, please contact our Technical Support at 480-275-8613 or email us at [support@nexus21.com](mailto:support@nexus21.com) for further troubleshooting.

# Connecting the Lift to your Home Control System

## Connecting the Nexus 21 Lift System to Other Control Systems

Use these instructions if you need to wire the Lift System directly to a Home Control System, like those made by Crestron, AMX, Control 4, RTI, etc. A common term for this method of integration is "connection by contact closure."

### Contents of Contact Closure Hardware Pack:

#### Step 1: Contact Closure Hardware Pack

This pack contains the following parts:

1 – *Contact Closure Cable*, RJ-45 to Relays

1 – *Height limit Insert*



Contact Closure Cable, RJ-45 to Relays



Height Limit Insert

#### Step 2: Connecting the Lift System to the Control System

Using the *Contact Closure Cable* to connect the three wires directly to the relays on your control module (see image below). Then connect the RJ-45 plug on the *Contact Closure Cable* to the Nexus 21 system, using either one of the two RJ-45 ports on the side of the Nexus 21 *Control Box*.

#### The colored wires function as follows:

**BLUE** = common (Pin 4 from RJ45) **GREEN** = Extend (Pin 5 from RJ45) **RED** = Retract (Pin 8 from RJ45)

#### Wire combinations for the relays:

The lift system uses two relays. One for "extend" and one for "retract." The common wire runs between both relays, by using the **BLUE common wire**, together with a jumper wire you supply.

**Relay 1 Extend:** **BLUE** common wire with **GREEN** normally open.

**Relay 2 Retract:** **BLUE** common wire (use jumper) with **RED** normally open.



Close-up View of RJ-45 Pins



#### Step 3: Setting a Height Limit for the Lift System

Begin with the Height Limit Insert **UNPLUGGED**. Then send the "UP" command from your control system and run the Lift System up to your desired height. Once the Lift System is at the desired height, send the "DOWN" command to stop the lift at the point. Now **PLUG** the Height Limit Insert into the available RJ45 port on the Nexus 21 Control Box. The Lift will now remember the height and always stop at that point. To change, unplug the Height Limit Insert and repeat Step 3.

For technical support or to ask questions, call Nexus 21 Customer Service, toll-free at (866) 500-5438.



(Intentionally Left Blank)

(Intentionally Left Blank)

(Intentionally Left Blank)

**nexus**   
CONCEALMENT SYSTEMS

**866.500.5438**