

NEXUS 21

TECHNOLOGY IN MOTION

**TV Lift System Model L-50en
Installation Instructions**

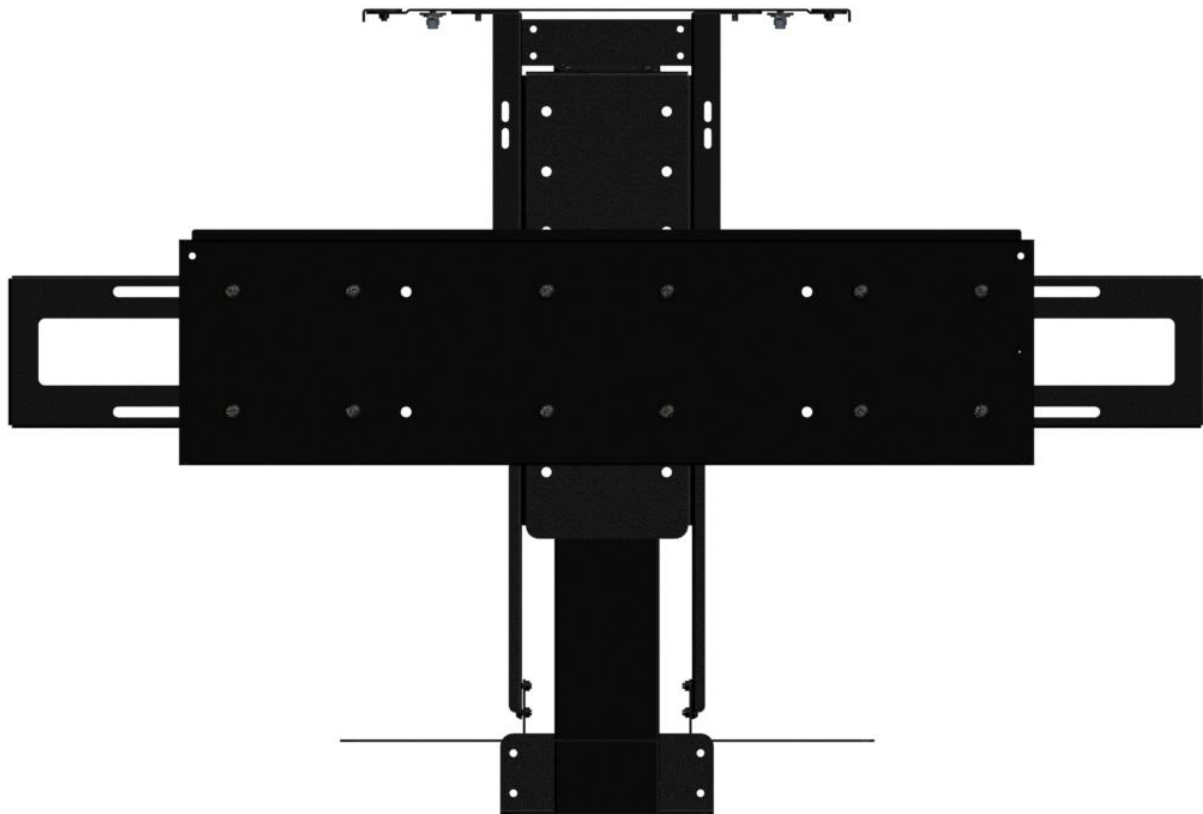

Below is a parts list describing all of the items included with the Model L-50en Lift System. You may also wish to refer to the dimensional diagram shown at the end of this document on page 29.

Before beginning assembly and installation, please make sure that you have all items included on the list. If any parts are missing or damaged, please contact Nexus 21. Our contact information is shown at the top of this page.

Parts List



Lift Column



Base Mount



Screen Support

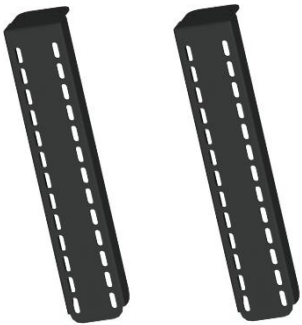

Top Support Brackets

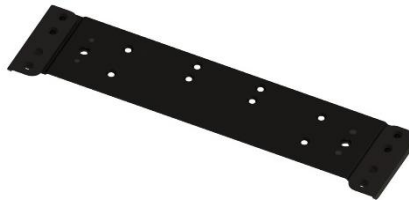

Top Plate



Column Clamp Extension



Column Clamp Base



Vertical Mounting Bars



Screen Back Plate

Parts List, continued

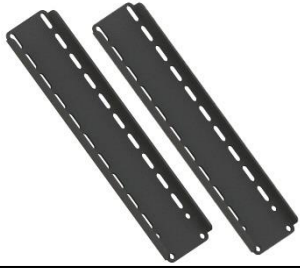

Accessory Mounting Bracket



Rear Support Bracket



Side Bracket



Control Box



Assorted TV Mounting Screws

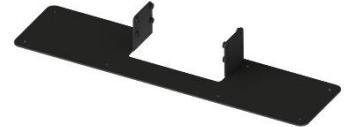

Bottom Plate

Cables

- **Motor Cable 2.5m (1)** – Black cable with white, six-pin plugs. Use this cable to connect the Lift Column to the Control Box.
- **Power Cable** – Connects Control Box to power outlet. Three feet long.
- **RF Cable (only present if you ordered the RF version of the Lift System)** – Use to connect the RF Receiver to the Control Box. Ends have RJ-45 connectors. One-foot long.

Hardware

1. Eight (8) -- 6 x 12mm BHMS (Button Head Machine Screw)
2. Four (4) -- 6 x 16 BHMS (Button Head Machine Screw)
3. Four (4) -- 3/8" – 16 x 3/4" BHMS (Button Head Machine Screw)
4. Four (4) – 6 x 12mm FHMS (Flat Head Machine Screw)
5. Four (4) – 6 x 16mm FHMS (Flat Head Machine Screw)
6. Four (4) -- #8 x 3/4" FHWS (Flat Head Wood Screw)
7. Two (2) -- #10 x 1-3/4" FHWS (Flat Head Wood Screw)
8. Eighteen (18) -- #10 x 3/4" THWS (Truss Head Wood Screw)
9. One (1) – Small Hex Key (4mm)
10. One (1) – Large Hex Key (7/32")
11. Four (4) – Universal Lid Catches
12. One (1) – Large Assorted TV Hardware Pack
13. Two (2) – Threaded Tapered Pins
14. Four (4) – Wire Clips
15. Four (4) – Snakeskin Ties
16. Four (4) – Plastic Wire Ties

Wire Management



The Lift System has no exposed gears or moving parts that can damage your wires, so wire management is simple. We have included a four-foot long "SNAKESKIN" sleeve, which is a state-of-the-art wire bundling and protection system (the sleeve can be cut shorter if you wish). The System also includes 4 Velcro end ties and 4 plastic ties. Use the Velcro ties at the ends of the SNAKESKIN, to close the ends of the sleeve and to keep the wires together inside it. Use the plastic ties to fasten the cable bundle in a fixed position, so it moves up and down with the lift.



SAFETY INFORMATION

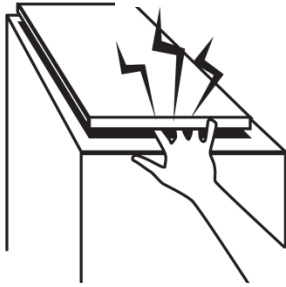

**SEVERE PERSONAL INJURY AND PROPERTY DAMAGE CAN RESULT FROM IMPROPER INSTALLATION OR ASSEMBLY.
READ THE FOLLOWING WARNINGS BEFORE BEGINNING:**

<p>TV HAZARD</p> 	<p>CABINET LID HAZARD</p> 
<p>CAUTION: Avoid contact with the TV and Lift System during operation. Use with caution.</p>	<p>CAUTION: The cabinet lid must be installed as described in the instructions, using the Steel Threaded Tapered Pins. Installing the cabinet lid in any other fashion will create hazardous pinch points that can cause serious personal injury.</p>

WARNINGS:

1. Do not use this product for any application other than those specified by Nexus 21.
2. Do not exceed the weight capacity. This can result in serious personal injury or damage to the equipment. It is the installer's responsibility to ensure that the total combined weight of all attached components does not exceed that of the maximum figure stated.
3. Follow all technical specifications and instructions during the installation.
4. Only use attachments/accessories specified by the manufacturer.
5. Close supervision is necessary when this system is being used by, or near, children, or disabled persons.
6. It is the responsibility of the installer to warn all potential users of the dangers of interfering with the mechanism during operation.
7. Read all technical instructions fully before installation and use. It is the installer's responsibility to ensure that all documentation is passed on to the users and read fully before operation.
8. Failure to provide adequate structural strengthening, prior to installation can result in serious personal injury or damage to the equipment. It is the installer's responsibility to ensure the structure to which the Lift System is affixed can support four times the weight of the system.
9. Risk of electric shock. Do not attempt to open the Control Box.
10. To reduce risk of fire or electric shock, do not expose parts to rain or other liquids.
11. Protect the power cord from being walked on or pinched.
12. Keep all documentation.
13. Heed all warnings.
14. Clean only with a dry cloth.
15. Refer all service questions to Nexus 21 if the system does not operate normally.

Nexus 21 disclaims any liability for modifications, improper installations, or installations over the specified weight range. Nexus 21 will not be liable for any damages arising out of the use of, or inability to use, Nexus 21 products. Nexus 21 bears no responsibility for incidental or consequential damages. This includes, but is not limited to, any labor charges for the servicing of Nexus 21 products performed by anyone other than Nexus 21.

Nexus 21 intends to make this and all documentation as accurate as possible. However, Nexus 21 makes no claim that the information contained herein covers all details, conditions or variations, nor does it provide for every possible contingency in connection with the installation or use of this product. The information contained in this document is subject to change without prior notice or obligation of any kind. Nexus 21 makes no representation of warranty, expressed or implied, regarding the information contained herein. Nexus 21 assumes no responsibility for accuracy, completeness or sufficiency of the information contained in this document.

Types of Controls for Nexus 21 Lift Systems

All Nexus 21 Lift Systems come standard with a **wireless remote control** and receiver. We offer a choice of two different types of remotes: IR and RF (both of which are explained in detail below). Our standard control type is RF, so unless you specifically requested the IR version when you made your purchase, you probably received the RF controls with this Lift System. The method of installation for each type of remote control is slightly different, so you should now identify which type of remote you have by reading below, and then follow the instructions for that type of remote.

NOTE: If you will be using the Lift with a home control system (like the ones made by companies such as Crestron or Control 4) the most common form of control is to WIRE IT DIRECTLY to the relays of your home control system. This direct-wire method is called **Integration by Contact Closure**, and is accomplished by using the Contact Closure Hardware that is supplied with the IR Control Kit to connect the Lift to your home control system.

Before You Begin the Installation: Identify Your Control Type

IR (Infrared) – This control option allows you to utilize a 3rd party universal style remote control to raise and lower the TV Lift. Your universal remote will “learn” the IR codes from the provided IR Handset, which will enable you to control the lift. The universal remote will then communicate with the “eye” located on the IR Receiver via your 3rd party emitter (or flasher). Instructions for setting the TV Lift’s travel limit are on Page 28.

NOTE: If you are NOT planning on using a 3rd party Universal Remote, switch to the RF setup. (There is no charge for swapping)

These are the parts included with IR controls:



Contact Closure Hardware



IR Receiver



IR Handset



Height Limit Insert

RF (Radio Frequency) - This system utilizes a wireless remote control handset that sends a radio signal to the RF Receiver. The radio signal can go through cabinet walls and does not require line-of-sight. Instructions for setting the Lift System travel limit are on Page 28.

TIP: Planning to integrate the TV Lift with your UNIVERSAL REMOTE CONTROL? The RF version of the Nexus 21 controls won't do it. Switch to IR.

These are the parts included with RF controls:



Backup Switch



RF Receiver



RF Handset



Height Limit Insert

Integration by Contact Closure – To direct-wire the TV Lift controls to a home control system (Crestron, Control 4, AMX, etc.) you will use the Contact Closure Hardware. You won't use any Nexus 21 receiver or handset for this type of control because you will use the handset or control pad that comes with your home control system. **Instructions for setting up the System using Contact Closure are on “Page 33”.**

Assembly and Mounting – Things to Think About First



SAFETY NOTICE:

- For proper support, the Lift System **MUST NOT** be attached to any material that is less than ¼” thick. This applies to BOTH the back and bottom mounting points.
- The Lift Column is **ONLY** designed and rated for VERTICAL, NON-INVERTED USE. **DO NOT MOUNT THIS LIFT SYSTEM UPSIDE DOWN or SIDEWAYS (HORIZONTALLY)!**

TIP: Inverted (drop-down) lift systems are available from Nexus 21. Contact Customer Service at (866) 500-5438.

Space requirements for the L-50en Lift System are located on pages 28-31



IMPORTANT NOTE: The Lift System must be mounted **as high up as possible inside the cabinet**, so that when the Lift is in the fully “DOWN” position (fully retracted), the top of the TV will be just underneath the lid of the cabinet. A 1/8” gap between the lid and the Top Plate is ideal.

Lift System height and mounting position:

The Top Support Brackets allow you to adjust the installation height of the Lift in ¼” increments if necessary. When fully assembled in the standard configuration, the HEIGHT of the Lift will be a minimum of 32.25” up to a maximum of 40.5” with the Top Support Brackets in the highest position. Reference the dimensional drawing for more information.

About the Cabinet Lid (Cabinet Top)



SAFETY NOTICE:

WARNING! YOU MUST NOT DIRECTLY SCREW THE CABINET LID (TOP) TO THE LIFT SYSTEM!! THIS CREATES HAZARDOUS “PINCH POINTS” AND MAY AFFECT THE OPERATION OF THE LIFT OR CAUSE DAMAGE TO THE CABINET TOP. For floating lids, **DO NOT USE SCREWS to attach the lid to the Lift System.** Instead, use the “Threaded Taper Pins”. This will keep the lid firmly in place, but will also allow it to **separate from the lift system** if anything (like a finger) gets in the way when the TV lowers.

Lid Style (There is only 1 Lid Style for this Lift Model) - Hinged Lid Incompatible

Floating Lid (Floating Top) – The top of the Enclosure sits on top of the Lift System and is removable. This is done using the Top Plate and Threaded Tapered Pins.

Table of Contents

- 1) Assembling and Installing the Actuation System
- 2) Connecting the Actuation System
- 3) Assembling the Lift System
- 4) Installing the Lift System
- 5) Attaching the Enclosure Box
- 6) Installing the Tapered Pins in the Floating Lid
- 7) Installing a Lid Catch
- 8) Attaching the TV
- 9) Cable & Component Management
- 10) Setting a Height Limit
- 11) Dimensional Drawing
- 12) Contact Closure Integration Info

Assembling and Installing the Actuation System

For these steps you will need the following parts:

- Lift Column
- Base Mount
- Column Clamp Extension
- Column Clamp Base
- (4) 6 x16 FHMS
- (2) 6 x 12 BHMS

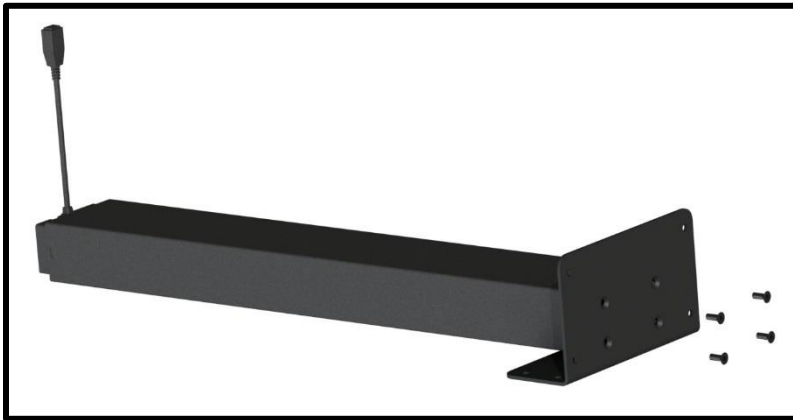
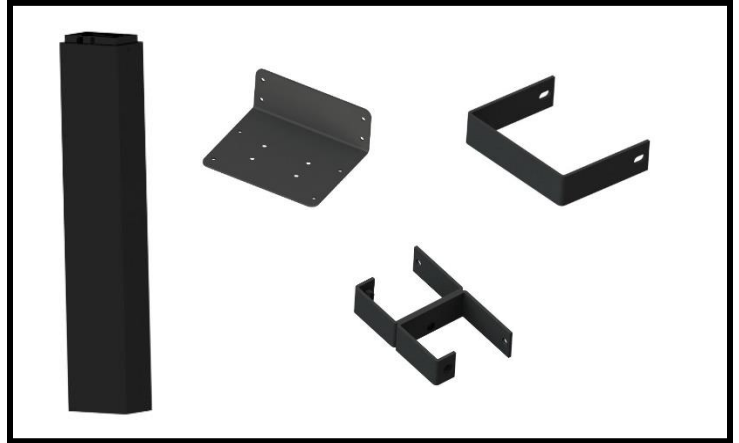

Step 1: Attach the Base Mount to the bottom of the Lift Column using (4) 6 x 16 FHMS Screws.

Note: Ensure the Pigtail for the Lift Column is facing towards the front of the Cabinet.

Step 2: Slide the Column Clamp Extension around the front face of the Lift Column so that the top of the it is 20" from the bottom of the Cabinet.

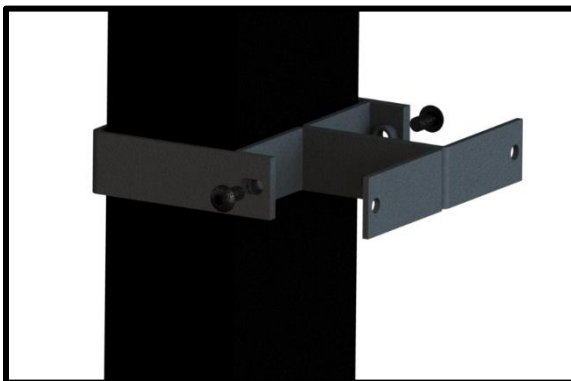
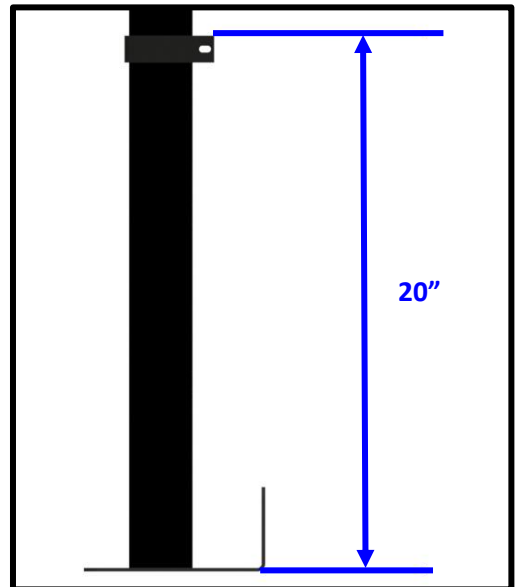

Step 3: Slide the Column Clamp Base into the Column Clamp Extension, then fasten the two together using (2) 6 x 12 BHMS Screws.

Connecting the Actuation System

For these steps you will need the following parts:

- Control Box
- 2.5m Motor Cable
- Wired Backup Switch
- RF Control Kit or CSI Control Kit
- Power Cord

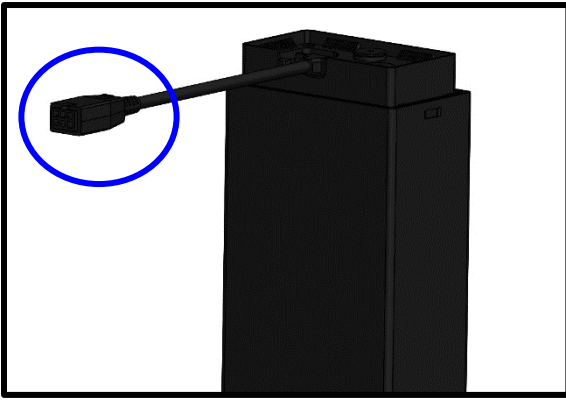
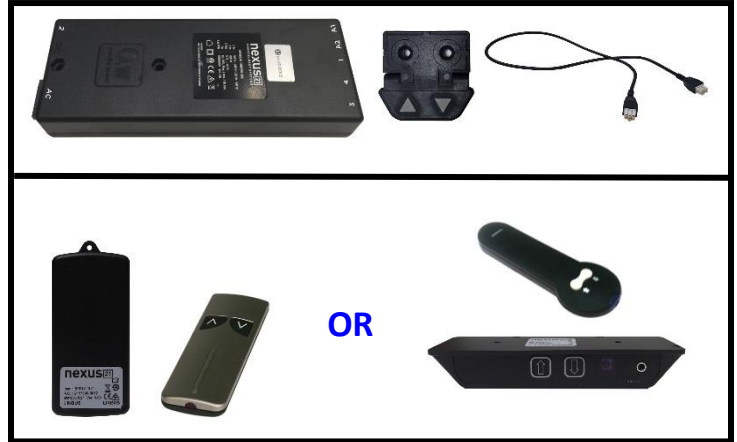

Step 4: Connect the 2.5m Motor Cable to the pigtail coming off of the top of the Lift Column.

Step 5: Connect the other end of the 2.5m Motor Cable to Port 1 on the Control Box.



Step 6: Connect the Wired Backup Switch to Port A1 on the Control Box. If you purchased the CSI Kit, connect the IR Receiver to Port A1 instead of the Wired Backup Switch.

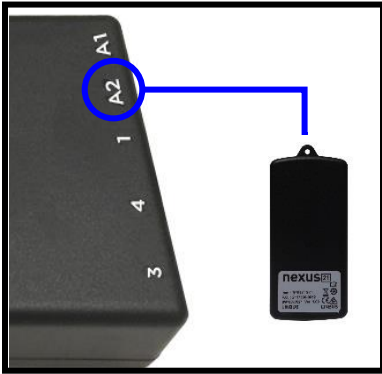

Step 7: Connect the RF Receiver to Port A2 on the Control Box. If you purchased the CSI Kit, leave this port empty for now.

Step 8: Connect the Power Cord to Port AC on the Control Box, then connect the other end of the Power Cord to a power outlet or receptacle.

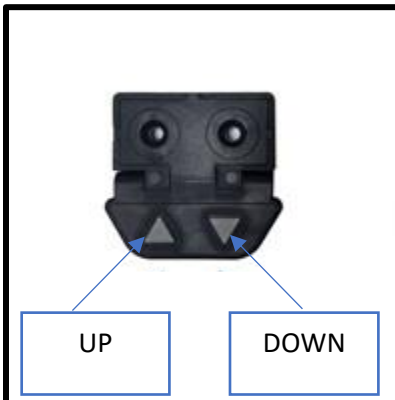

Step 9: Reinitialize the lift, by pressing the DOWN button on the Wired Backup Switch or IR Receiver once, then pressing and holding it a second time for 5-10 seconds.

Note: You should see or hear the lift jog up and down very slightly, if you do not see or hear it the first time, try it again.

Assembling the Lift System



For these steps you will need the following parts:

- Screen Support
- Rear Support Bracket
- Accessory Mounting Brackets
- Bottom Plate
- (4) 6 x 16 BHMS Screws
- (16) 6 x 12 BHMS Screws

Step 10: Place the Screen Support on top of the Lift Column then place the Rear Support Bracket on top of it, aligning the Screen Support, Rear Support Bracket and Lift Column holes, then fasten them together using (4) 6 x 16 BHMS Screws. Use the photo below for reference.

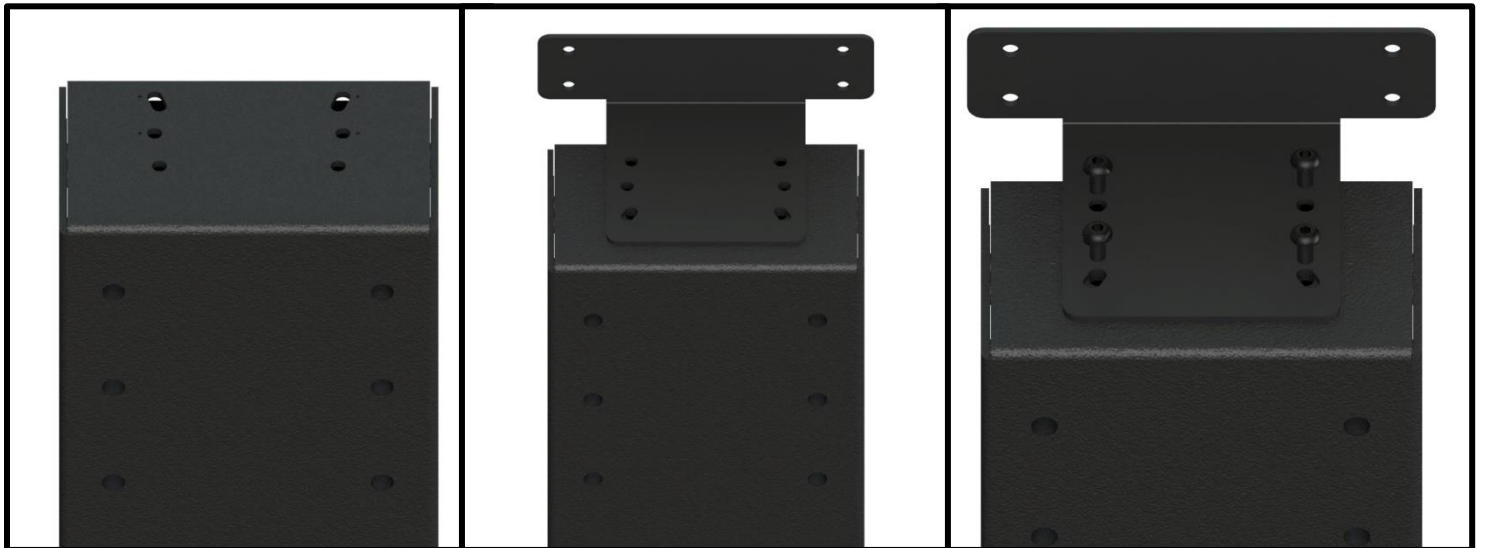

Step 11: Attach both Accessory Mounting Brackets to the Lower Left and Lower Right side of the Screen Support using (8) 6 x 12 BHMS Screws, (4) per side.

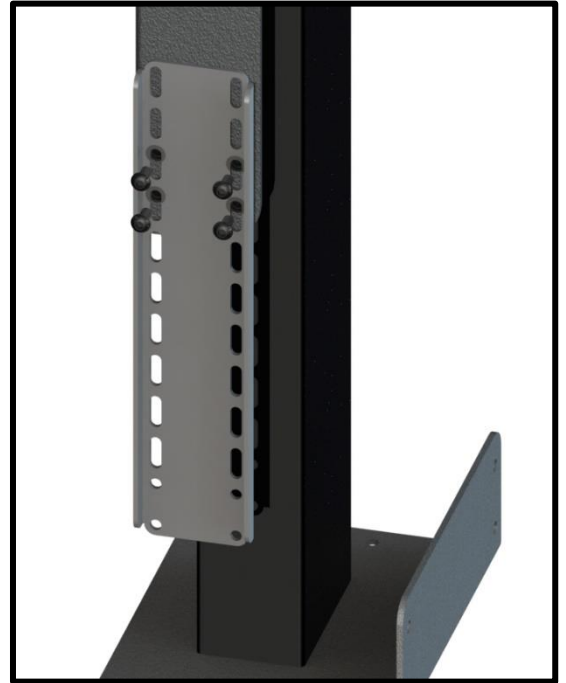

Step 12: Attach the Bottom Plate to the Accessory Mounting Brackets using (8) 6 x 12 BHMS Screws, (4) per side.

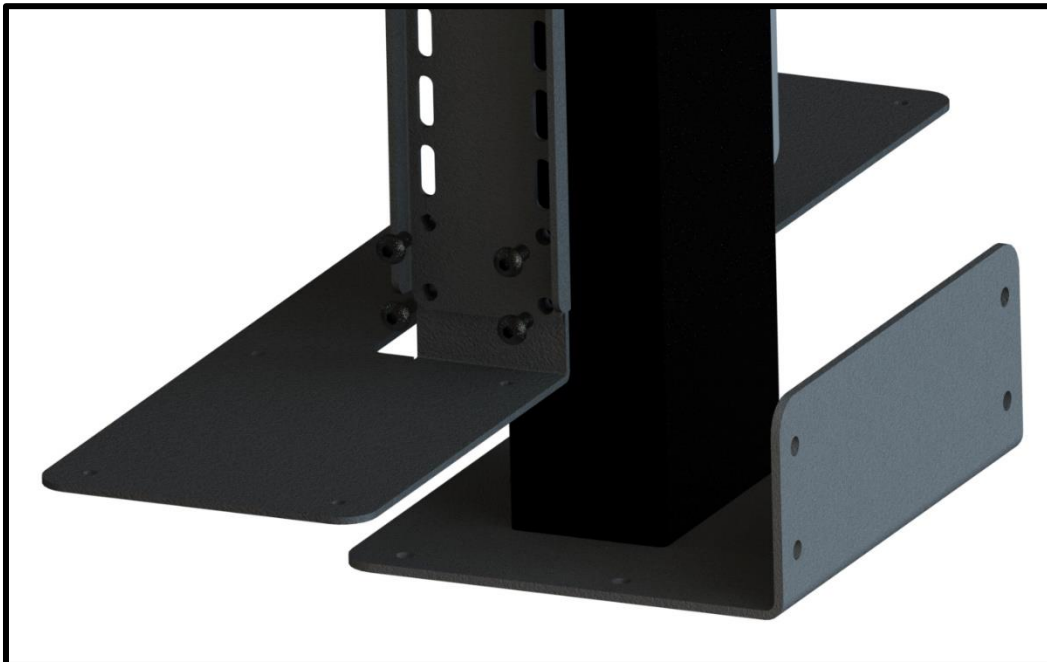

Installing the Lift System

For these steps you will need the following parts:

- (10) #10 x 3/4" THWS

Step 13: Center the Lift Column inside the Cabinet.

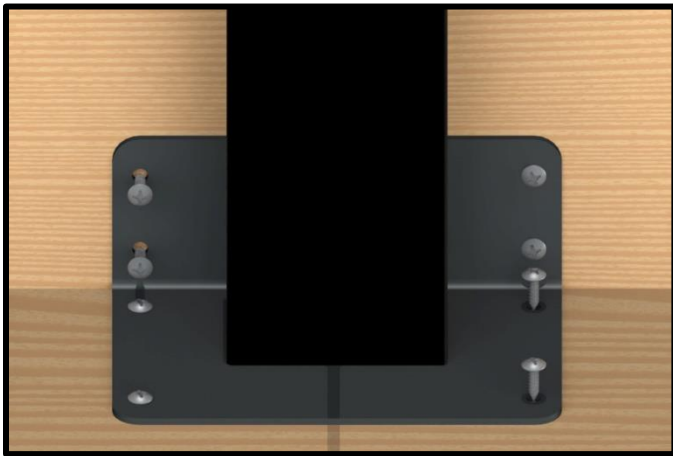
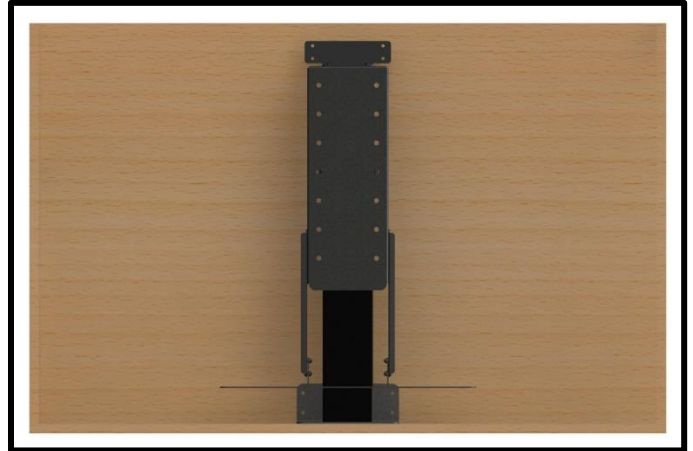

Step 14: Fasten the Base Mount to both the Bottom and Rear Panel of the Cabinet using (8) #10 x 3/4" THWS Screws.

Step 15: Press the UP button on the Wired Backup Switch or IR Receiver to extend the Lift System.

Note: You can press the DOWN button while it is moving up to STOP it at any point.

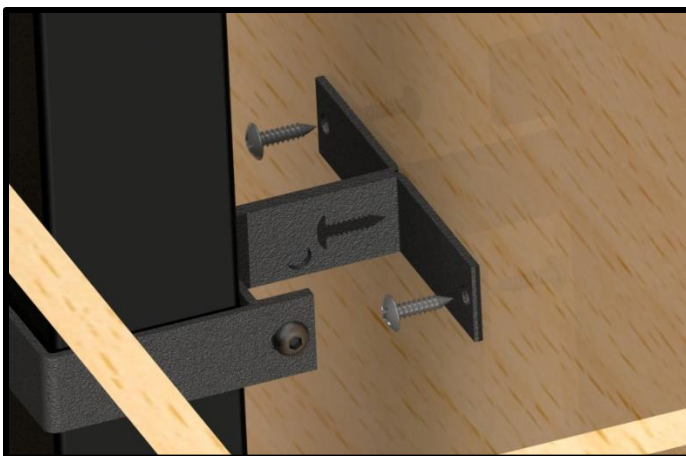
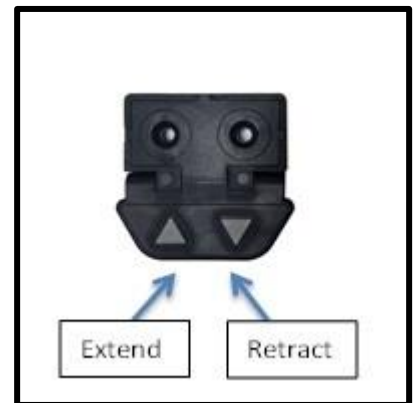

Step 16: Fasten the Column Clamp to the Rear Panel using (2) #10 x 3/4" THWS Screws

Attaching the Enclosure Box

For these steps you will need the following parts:

- Screen Back Plate
- Side Panel Brackets
- Top Support Brackets
- Top Plate
- (28) #10 x 3/4" THWS Screws
- (12) 3/8" - 16 x 3/4" BHMS Screws
- (8) 3/8" - 16 x 3/4" Nyloc Nuts
- (8) 6 x 12 BHMS Screws
- (4) 6 x 12 FHMS Screws

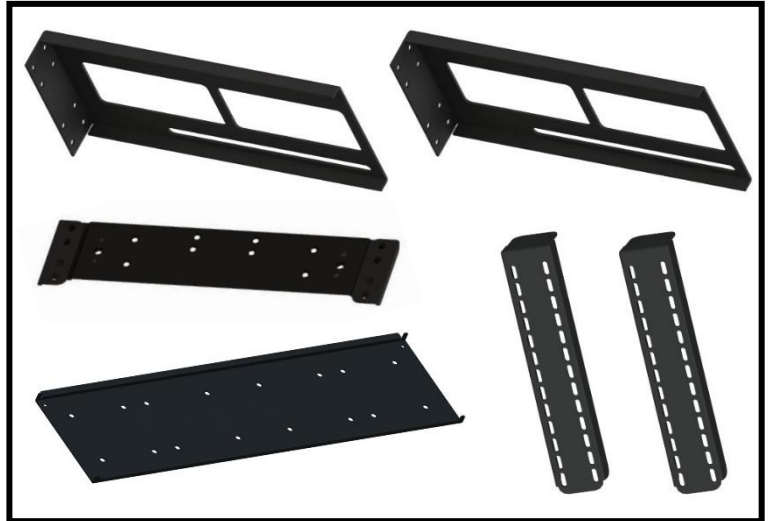

Step 17: Check that the Enclosure Box has a 7.875" x 6.125" rectangular cutout in the center of its Bottom Panel. Reference the photo below and page 2 of the Dimension Drawing (Page 29) contained within this manual for more information.

Note: This is required in order to slide the Enclosure Box over the top of the Screen Support Bracket and down on to the Bottom Plate.

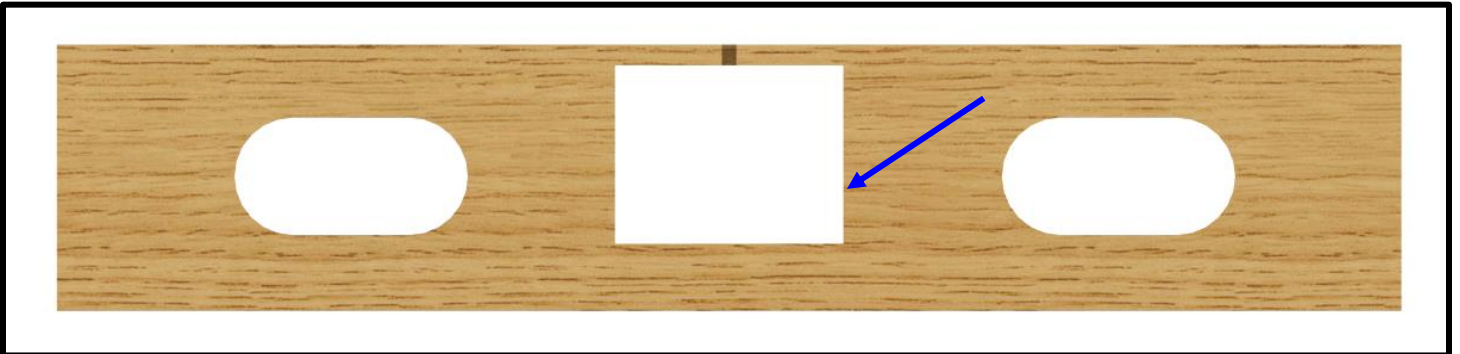

Step 18: Check that the Enclosure Box has a 0.5" wide slot cut into its Rear Panel. Ensure the slot is high enough on the Back Panel of the Enclosure to accommodate the Column Clamp Base.

Note: The Column Clamp Base will slide into this slot while it is retracting which requires the slot to be high enough on the Back Panel so that it does not cause an obstruction to the Lift System.

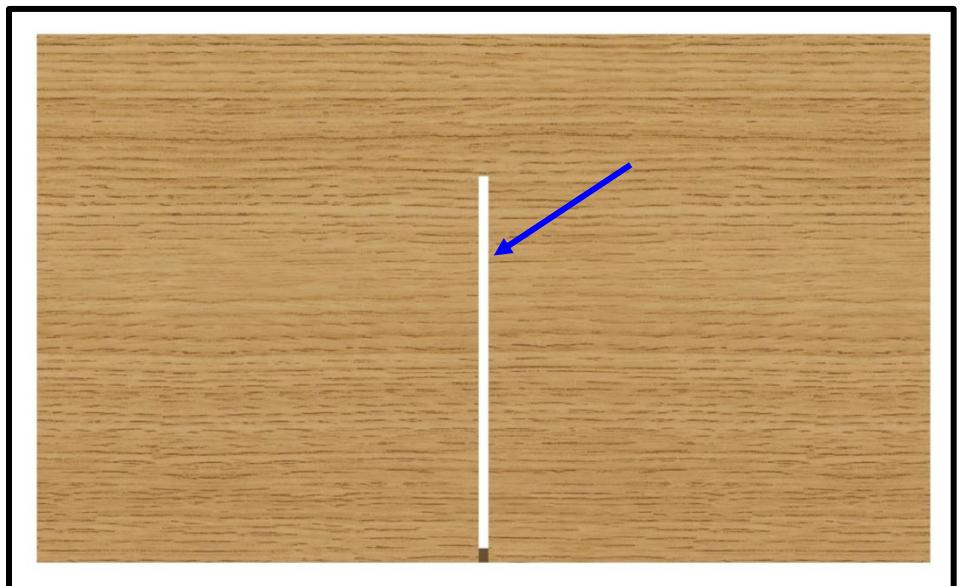



Step 19: Slide the Enclosure Box over the Screen Support and on to the Bottom Plate.

Step 20: Center the Enclosure Box on the Lift System, then fasten the Rear Support Bracket to the Rear Panel of the Enclosure Box using (4) #10 x $\frac{3}{4}$ " THWS Screws.

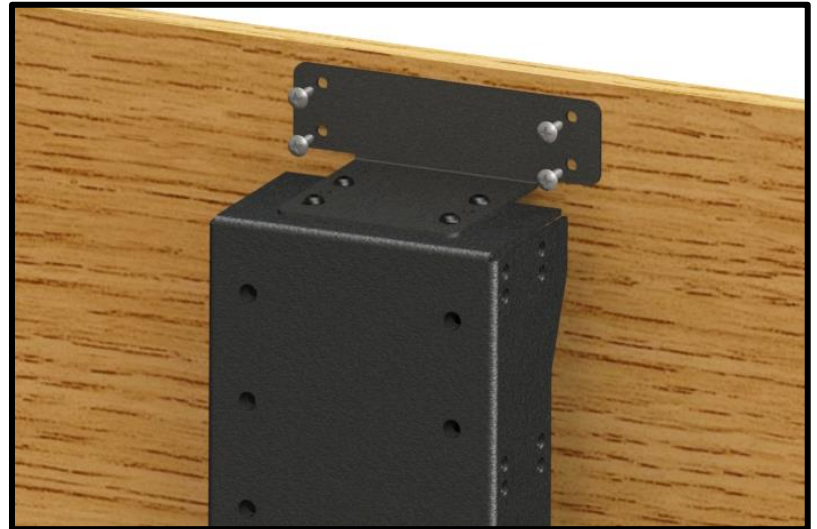

Step 21: Test run the Lift System by running it down and back up a few times to ensure the Rear Slot is cut high enough on the Back Panel of the Enclosure Box and that no rubbing occurs within the slot.



Step 22: Fasten the Rear Panel of the Enclosure Box to the Bottom Plate using (8) #10 x $\frac{3}{4}$ " THWS Screws.

Step 23: Attach the Screen Back Plate to the Screen Support using (4) 3/8"-16 x 3/4" BHMS Screws.

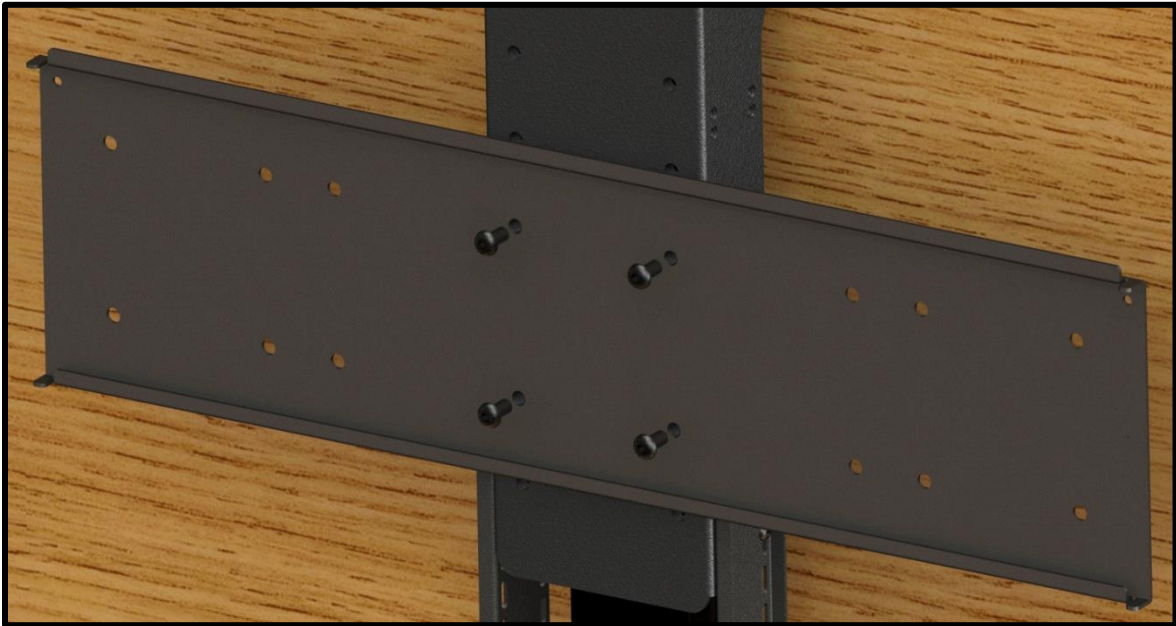

Step 24: Attach the Side Panel Brackets to the Left and Right side of the Screen Back Plate using (8) 3/8"-16 x 3/4" BHMS Screws and (8) 3/8"-16 x 3/4" Nyloc Nuts, (4) of each per side.

Note: For wider Enclosure Boxes, (2) of each Screw and Nut can be used instead of (4) on each side.

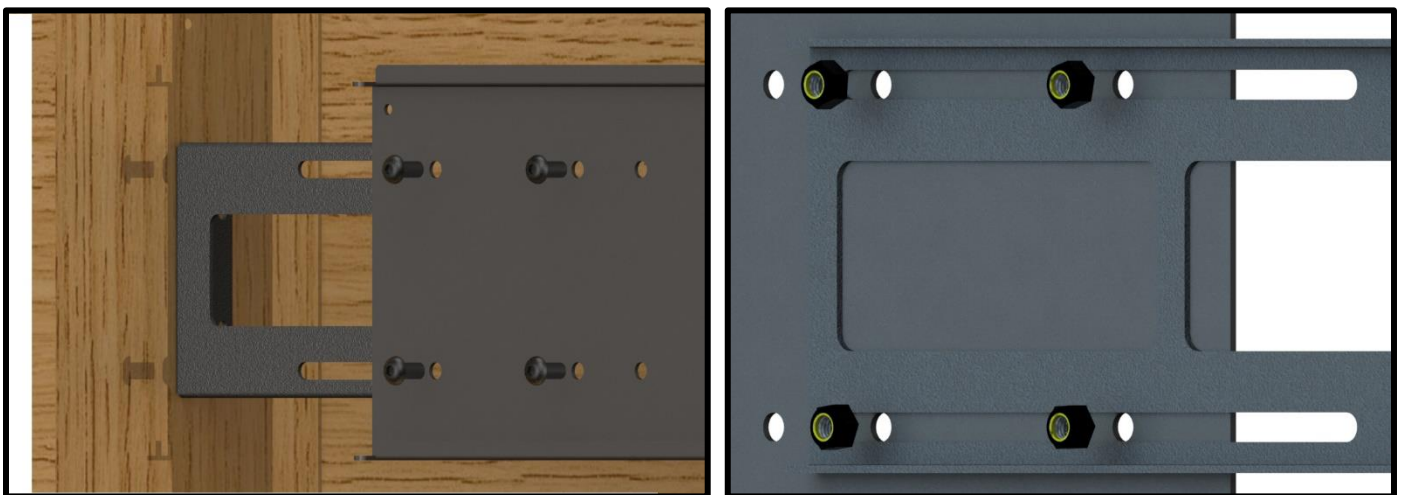

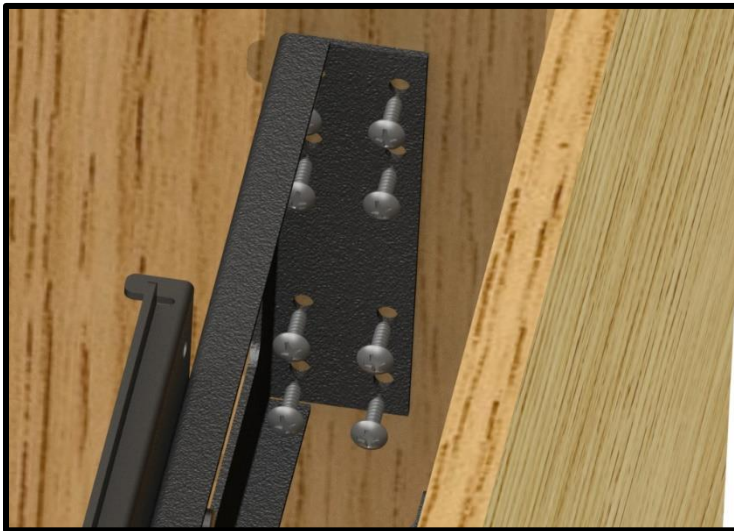

Step 25: Attach the Side Panel Brackets to the Left and Right side of the Enclosure Box using (16) #10 x $\frac{3}{4}$ " THWS Screws.

Step 26: Attach the Top Support Brackets to the Upper Left and Upper Right Side of the Screen Support Bracket using (8) 6 x 12 BHMS Screws, (4) per side.

Note: Adjust the Top Support Brackets so that they rest about $\frac{1}{4}$ " below the Top Edge of the Enclosure Box.

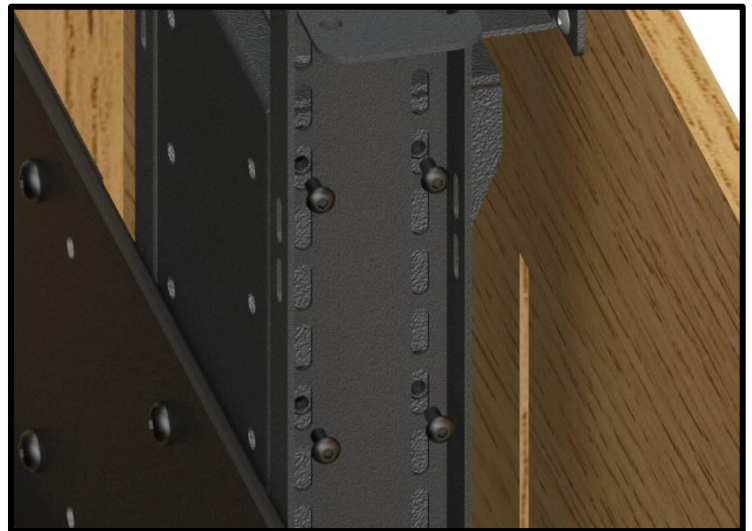

Step 27: Attach the Top Plate to the Top of both Top Support Brackets using (4) 6 x 12 FHMS Screws.



Installing the Tapered Pins in the Floating Lid

For these steps you will need the following parts:

- Threaded Tapered Pins
- 7/32" Drill Bit
- Phillips Screw Driver
- Cabinet Lid
- (Optional) Wood Glue
- (Granite Only) Epoxy

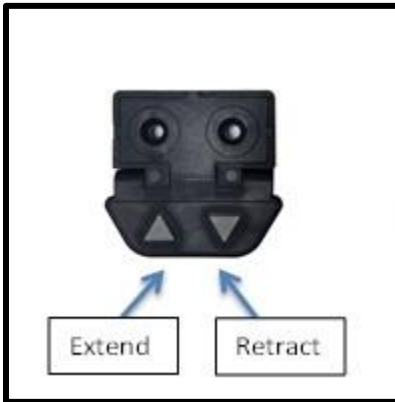

Step 28: Full retract the Lift System by pressing the DOWN button on the Wired Backup Switch or IR Receiver.

Step 29: Position the Cabinet lid so that it is centered within the Cabinet Lid Cutout.



Step 30: Run the Lift System up by pressing the UP button on the Wired Backup Switch, ensuring the Lid stays in position and is not bumped, shifted, or moved out of place.



Step 31: Using a pencil, sharpie, or felt-tipped pen, mark the position for the Tapered Pins from the underside of the Top Plate. Use the photo to the Left for reference.

Step 32: Remove the Lid, and drill two holes $\frac{1}{2}$ " deep in the two marked positions using a $\frac{7}{32}$ " drill bit.



Step 33: Thread the provided Tapered Pins into the holes using a phillips screws driver.

Note: Glue can be used to further secure the pins into position. If using granite, you can bore a hole slightly larger than the diameter of the pins and Epoxy them into place.

Step 34: Place the Lid on top of the Lift System again, lining the Tapered Pins up with the holes used to locate the pins in Step 31.



Step 35: Run the Lift System down then back up to test and ensure the position of the lid is correct. If the position of the pins are off, loosen the nuts for the Pin Nests located on the underside of the Lid and position the Lid so that it is centered within the Cabinet Lid Cutout.

Note: The Pin Nests are adjustable $\frac{1}{4}$ " in every direction.

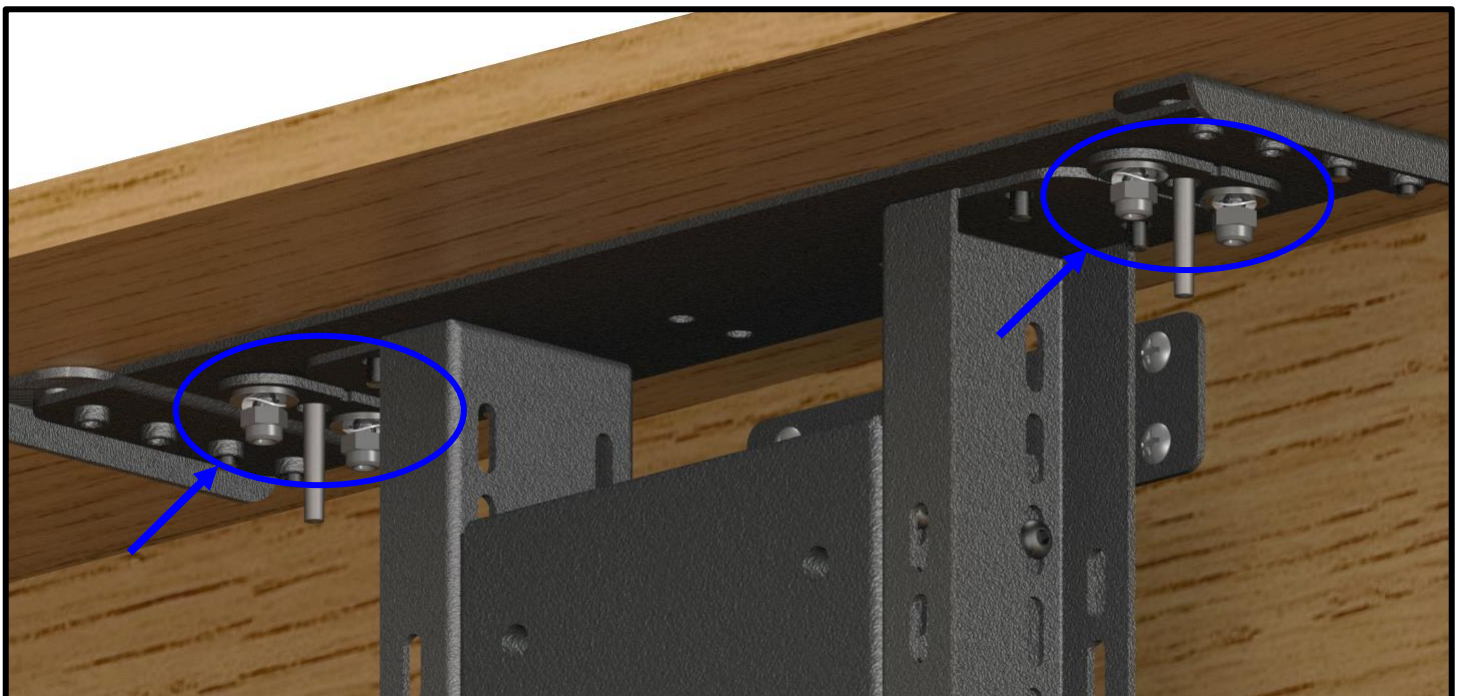

Installing the Lid Catch

In order for the Lid to always rest flush with the surrounding cabinet or countertop, you must install a Lid Catch. A Lid Catch functions similar to a “manhole cover” in that it catches the lid allowing the Lift System to breakaway and allow gravity to ensure the lid sits flush. A few examples of this are depicted below:

Using the provided Universal Lid Catches:



Alternative using a wooden “Lip” or “Catch” built into the cabinet:

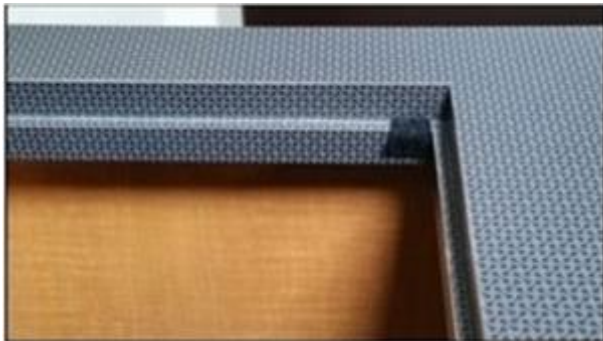

Attaching the TV

For these steps you will need the following parts:

- Vertical Mounting
- Large Assorted TV Hardware Pack
- Screen Locks

Step 36: Attach the Vertical Mounting Bars to the back of the TV using the provided Large Assorted TV Hardware Pack.

All hardware mentioned in these diagrams is inside the Large Assorted TV Hardware Pack, however other hardware may be necessary based on TV model. Refer to the TV Manual for screw sizing information.

A Flat/Unobstructed Back

Diagram "A" installation procedure:

- 1) Place the flat screen TV face down on a protected surface.
- 2) Position the Vertical Mounting Bars equidistant from the bottom and top of the TV, with the slots facing toward the top of the TV.

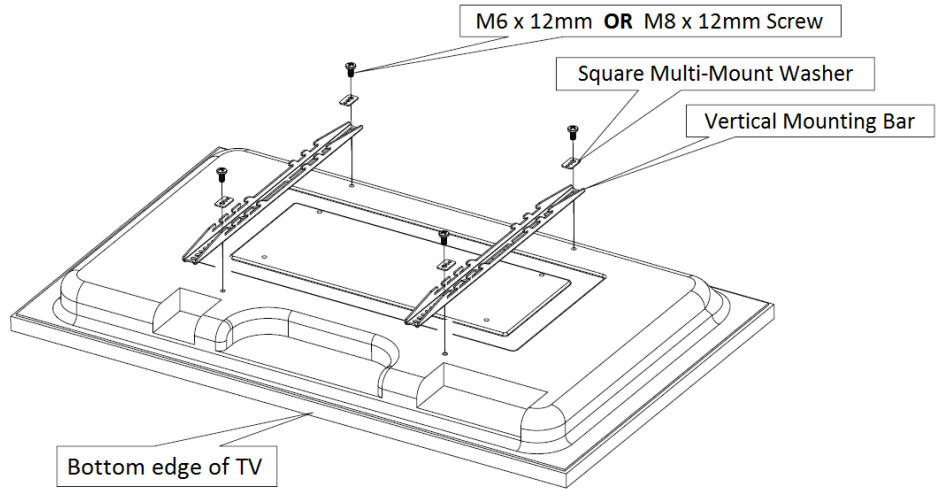

- 3) Using the four (4) Square Multi-Mount washers and the TV mounting screws selected from the bag, attach and tighten the hardware.

DO NOT OVERTIGHTEN HARDWARE. DAMAGE TO TV MAY RESULT.

B Irregular/Obstructed Back

Diagram "B" installation procedure:

- 1) Place the flat screen TV face down on a protected surface.
- 2) Position the Vertical Mounting Bars equidistant from the bottom and top of the TV, with the slots facing toward the top of the TV.

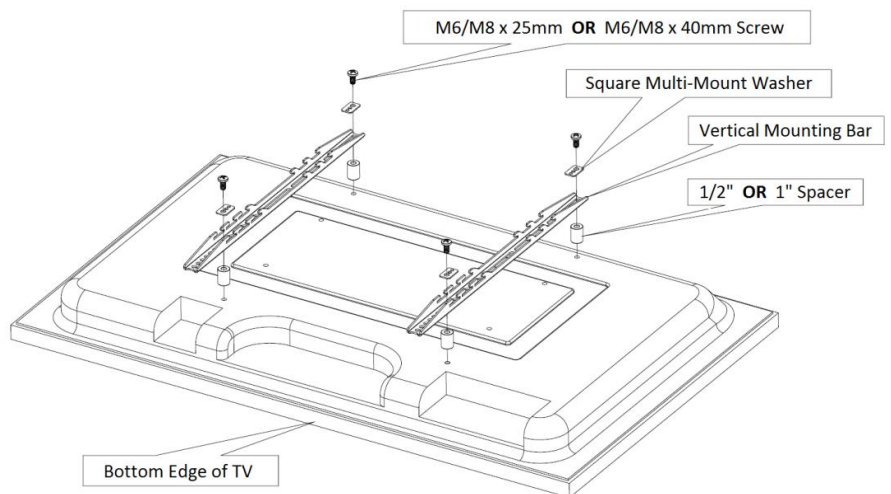

- 3) Using the four (4) spacers needed,
- 4) Square Multi-Mount washers and the TV mounting screws selected from the bag, attach and tighten the hardware.

The hardware will be used in this order (as shown in the diagram above):

TV, Spacers, Vertical Mounting Bars, Square Multi-Mount Washers, TV Mounting Screws.

DO NOT OVERTIGHTEN HARDWARE. DAMAGE TO TV MAY RESULT.

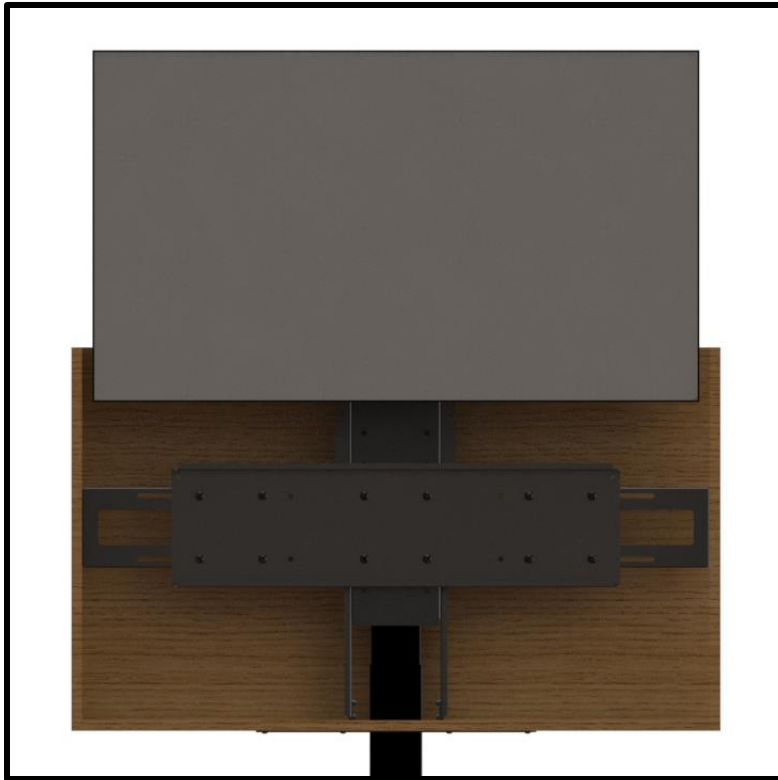

Step 37: Mount the TV to the Lift System by hanging the Vertical Mounting Bars on the Screen Back Plate.

Note: The Lid and Top Plate can be removed for this step if the clearance around the TV is tight.

Step 38: Check to make sure the TV is centered within the panels of the Enclosure Box, there should be at minimum 0.75" of Clearance all around the TV.

Note: To adjust the position of the TV within the Enclosure Box you can move the position of the Vertical Mounting Bars along the Back of the TV, hang the TV on a different set of hooks on the Vertical Mounting Bars, or move the position of the Screen Back Plate up or down along the Screen Support

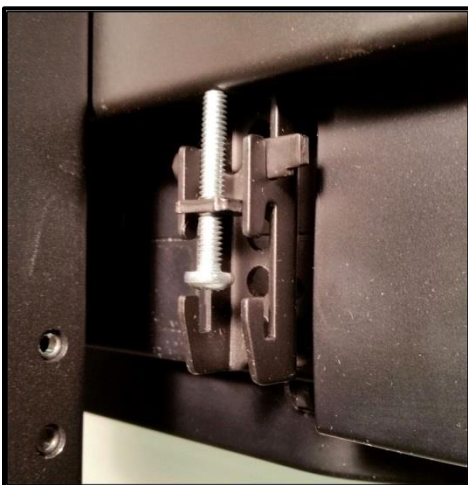
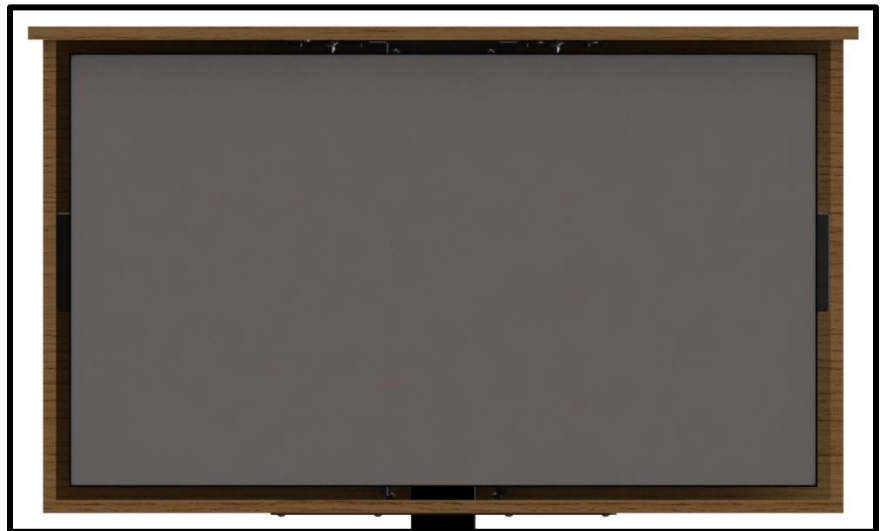

Step 39: Once the position is finalized, remove the lid and insert the Screen Locks into the Lower Section of hooks on the Vertical Mounting Bars that rest right below the Screen Back Plate and fasten them using a Phillips Screw Driver.

Cable & Component Management

For these steps you will need the following parts:

- #10 x 1 3/4" FHWS
- (2) #6 x 3/4" RHWS (RF Controls)
- (2) #8 x 3/4" FHWS (RF Controls)
- (2) #8x 3/4" FHWS (CSI controls)

Step 40: Manage the cables for the Lift System and TV so that they run down through the Ventilation Slots or Center Cutout in the Bottom Panel of the Enclosure Box.

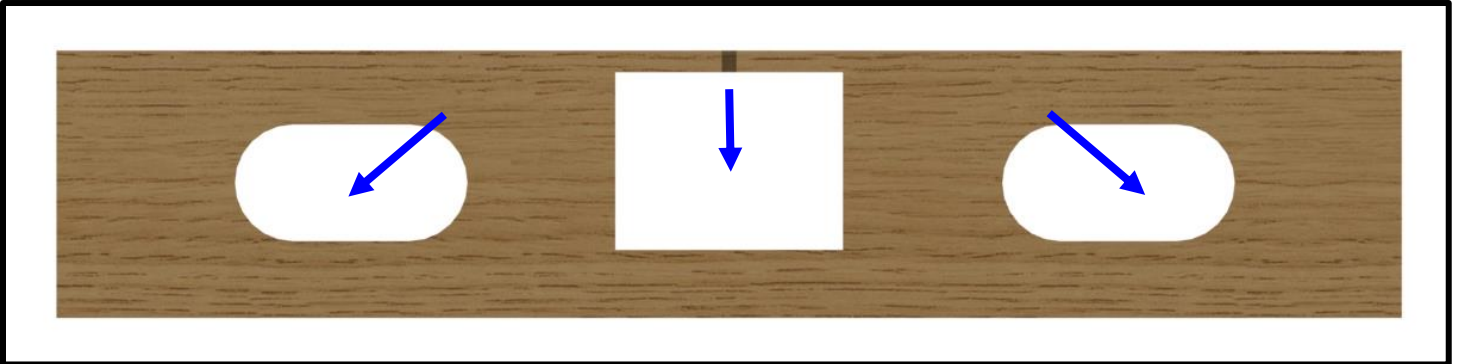

Step 41a: Place the Control Box in a location near an access panel at the bottom of the Cabinet or if the Cabinet allows it, near the Cabinet Opening so that when the Lid is removed the Control Box can be accessed.

Note: A 4.5m Motor Cable (About 15 ft) can be provided upon request if remotely locating the Control Box and Controls is necessary.

Step 41b: Mount the Control Box to the panel of your choosing using (2) #10 x 1 3/4" FHWS Screws.

Note: Ensure there will be enough slack on the Motor Cable to allow the Lift System to fully extend and there is enough room nearby to mount the RF and Wired Backup Switch or IR Receiver.

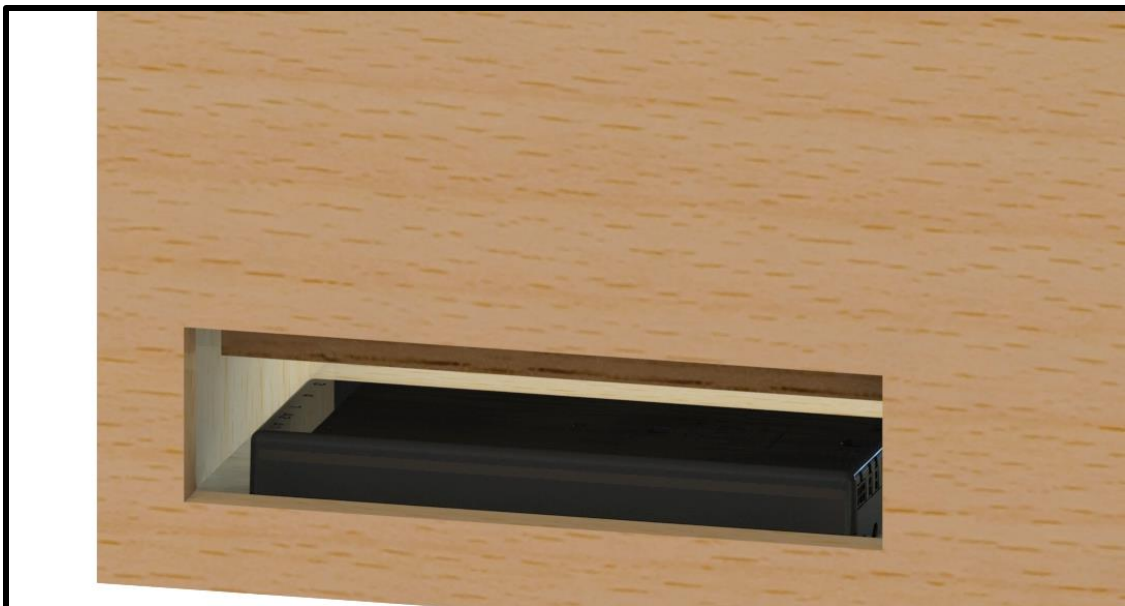

Step 42: Mount the RF Receiver to the panel of your choosing using (2) #6 x $\frac{3}{4}$ " RHWS Screws and mount the Wired Backup Switch using (2) #8 x $\frac{3}{4}$ " FHWS Screws. If you purchased the CSI Kit, mount the IR Receiver to the panel of your choosing using (2) #8 x $\frac{3}{4}$ " FHWS Screws.



Setting a Height Limit

This lift system has 39.25" of travel [extension or stroke], if your installation requires less than the maximum travel of the system, follow the steps below to limit it:

1. Extend the lift to your desired position.
2. Tap the DOWN button to stop the lift once it reaches your desired height.
3. Plug the Height Limit Insert into an available RJ45/Phone port on either the Control Box or RF Receiver.
4. Fully retract the lift by pressing the DOWN button and extend it again to test the position.

About Lower Limits:

You cannot set a lower limit on any of our Lift Systems as the lower limit is fixed. The reason is because this is the position in which the lift systems starts and/or initializes from. If you are having an issue where a lower limit may seem necessary, contact Technical Support at 480-275-8613 for assistance as a lower limit should never be necessary on any of our products due to the adjustment built into the bracketry.

MODEL L-50EN DIAGRAM

PRIMARY ENCLOSURE DIMENSIONS - PAGE 1 OF 4

QUICK REFERENCE DIMENSION GUIDE (1 OF 2)
(USE WHICHEVER IS GREATER)

TV DIMENSIONS: W _____ H _____ D _____
 INTERIOR ENCLOSURE HEIGHT: $H + 1.5"$ [39] = _____ OR $26"$ [661]
 CANNOT EXCEED $37.75"$ [959]
 INTERIOR ENCLOSURE WIDTH: $W + 1.5"$ [39] = _____ OR $37.75"$ [959]
 CANNOT EXCEED $54.625"$ [1388]
 INTERIOR ENCLOSURE DEPTH: $D + 6.125"$ [156] = _____ OR $7.25"$ [185]

INTERIOR ENCLOSURE WIDTH = TV WIDTH + 1.5" [39] OR 37.75" [959],
 WHICHEVER IS GREATER; CANNOT EXCEED 54.625" [1388]

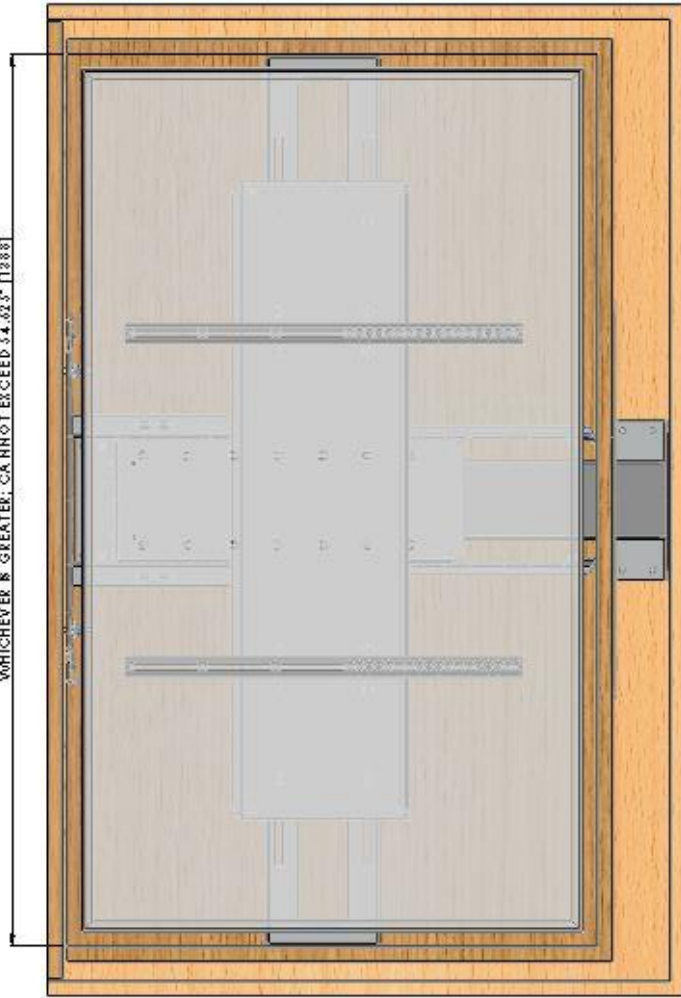

LID CUT-OUT DEPTH =
 INTERIOR ENCLOSURE DEPTH + 2.5" [64]
 OR 9.25" [248], WHICHEVER IS GREATER

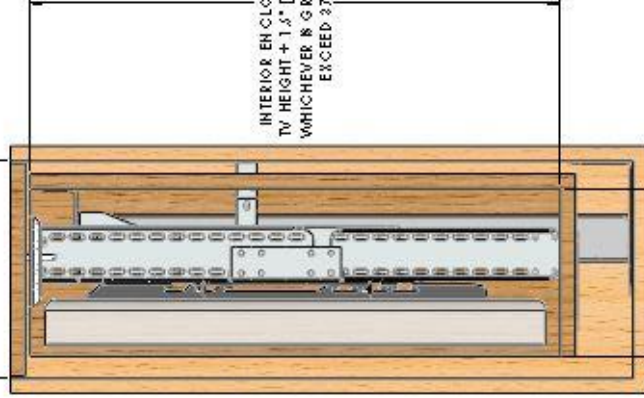

INTERIOR ENCLOSURE HEIGHT =
 TV HEIGHT + 1.5" [39] OR 26" [661],
 WHICHEVER IS GREATER; CANNOT
 EXCEED 37.75" [959]

INTERIOR ENCLOSURE DEPTH =
 TV DEPTH + 6.125" [156] OR 7.25" [185],
 WHICHEVER IS GREATER

NOTES:

1. THE CABINET BOX AND ENCLOSURE BOX SHOWN IN THE DIAGRAM IS FOR REFERENCE ONLY AND THEY ARE NOT PROVIDED WITH THE LIFTSYSTEM
2. FOR ENCLOSURE REFERENCE DIMENSIONS SEE PAGE 2 OF THIS DIAGRAM FOR CABINET DIMENSIONS SEE PAGES 3 AND 4
3. DIMENSIONAL EQUATIONS SHOWN ON THIS PAGE OF THE DIAGRAM ARE TO BE USED WITH THE DIMENSIONAL EQUATIONS FOUND ON PAGE 3
4. ALL DIMENSIONS SHOWN IN INCHES WITH MILLIMETERS SHOWN IN []
5. FOR THIS LIFT MODEL, THE LENGTH OF ITS TRAVEL (EXTENSION OF STROKE) IS 39.25" [998]
6. TO FULLY EXPOSE THE TV AND ENCLOSURE, INTERIOR ENCLOSURE HEIGHT + 0.75" [20] + LID THICKNESS CANNOT EXCEED 39.25" [998]
7. FOR THIS LIFT MODEL, THE TOTAL WEIGHT CAPACITY IS 100 LBS [45 KG] (TV, ENCLOSURE BOX, AND LID)
8. HEIGHT OF THIS MODEL IS ADJUSTABLE IN 1/4" [7] INCREMENTS UP TO 9.25" [235] MINIMUM HEIGHT = 31.25" [794]; MAXIMUM HEIGHT = 40.5" [1029]
9. WHEN DETERMINING TV HEIGHT, ALWAYS USE MANUFACTURERS SUPPLIED TV "WITH OUTSTAND" HEIGHT
10. LIFT MECHANISM IS POWDER COATED BLACK STEEL COLORS IN DIAGRAM ARE FOR CLARITY ONLY

NEXUS 21

© COPYRIGHT 2017. ALL RIGHTS RESERVED.

MODEL L-50EN DIAGRAM

ENCLOSURE REFERENCE DIMENSIONS - PAGE 2 OF 4

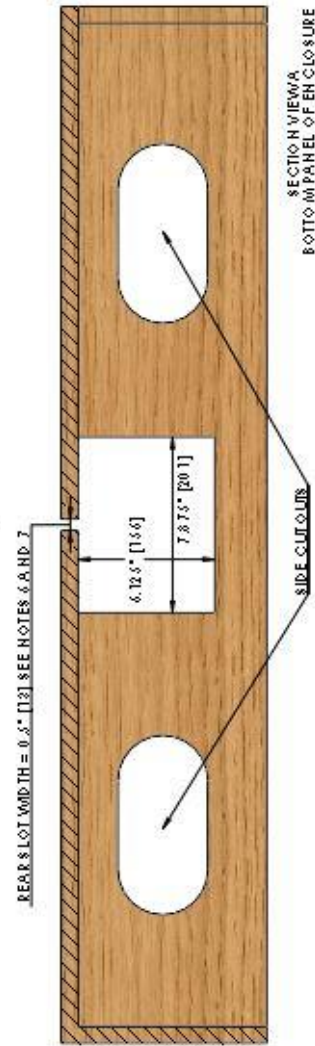
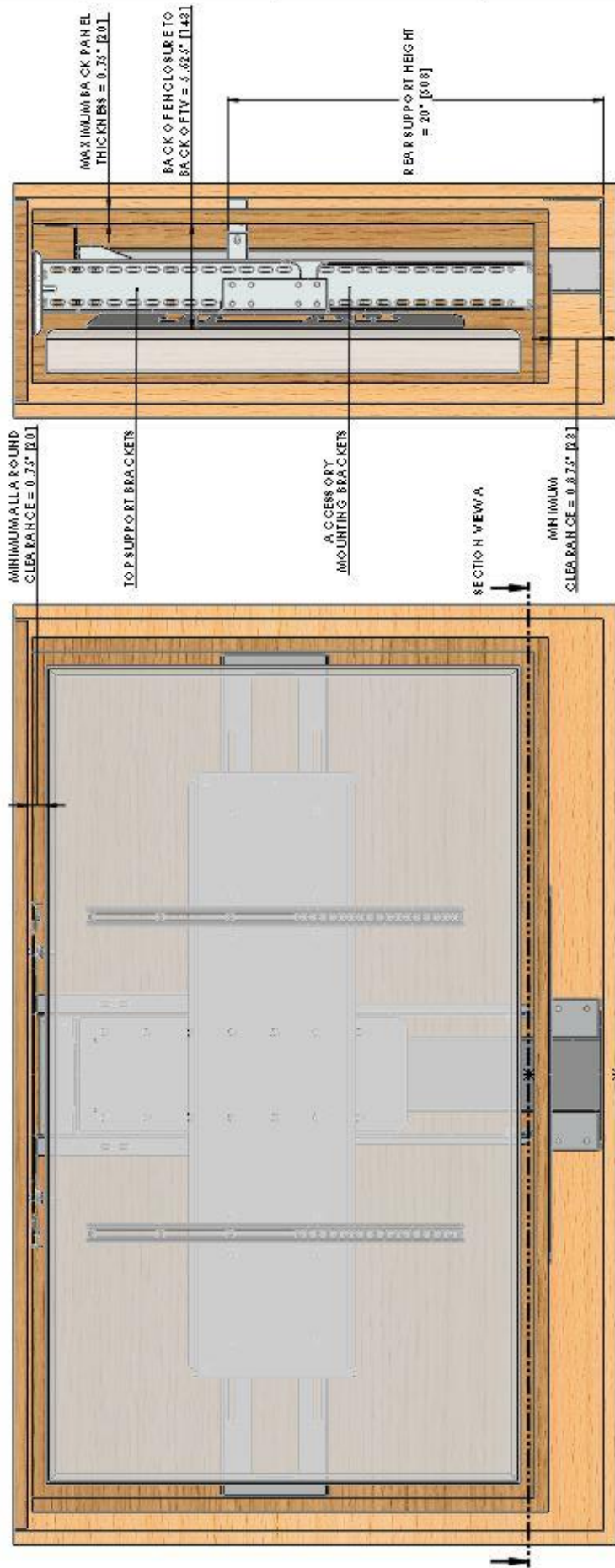

- NOTES:
1. ALL PANEL THICKNESSES FOR THE ENCLOSURE CANNOT EXCEED 0.75".
 2. TOP PANEL OF ENCLOSURE IS DESIGNED TO FLOAT IN THE PROVIDED TAPERED PINS AND CANNOT BE FASTENED TO THE LIFT.
 3. SECTION VIEW A REPRESENTS THE BOTTOM PANEL OF THE ENCLOSURE BOX.
 4. BOTTOM PANEL OF ENCLOSURE MUST HAVE A CENTER CUTOUT TO ACCOMMODATE LIFT COLUMN AND BRACKETRY.
 5. SIDE CUTOUTS RECOMMENDED FOR VENTILATION AND CABLE MANAGEMENT.
 6. A 0.625" WIDE REAR SLOT MUST BE CUT IN THE BACK PANEL OF THE ENCLOSURE TO ACCOMMODATE THE REAR SUPPORT BRACKET.
 7. THE REAR SLOT MUST BE HIGH ENOUGH ON BACK PANEL OF ENCLOSURE TO ACCOMMODATE THE REAR SUPPORT BRACKET.
 8. TOP SUPPORT BRACKETS ALLOW TOP PLATE TO BE ADJUSTED FLUSH WITH UNDERSIDE OF ENCLOSURE TOP PANEL.
 9. ACCESSORY MOUNTING BRACKETS ALLOW BOTTOM PLATE TO BE ADJUSTED FLUSH WITH UNDERSIDE OF ENCLOSURE BOTTOM PANEL.

NEXUS 21
 COPYRIGHT 2017. ALL RIGHTS RESERVED.

MODEL L-50EN DIAGRAM

PRIMARY CABINET DIMENSIONS - PAGE 3 OF 4

QUICK REFERENCED DIMENSION GUIDE (2 OF 2)
(USE WHICHEVER IS GREATER)
(INTERIOR ENCLOSURE DIMENSIONS FROM QUICK REFERENCE ON PAGE 1)

INTERIOR ENCLOSURE DIMENSIONS: W _____, H _____, D _____

INTERIOR CABINET HEIGHT: $H + 2.5"$ [64] = _____ OR $31.25"$ [794]

INTERIOR CABINET WIDTH: $W + 3.5"$ [89] = _____ OR $41.25"$ [1048]

INTERIOR CABINET DEPTH: $D + 2.5"$ [64] = _____ OR $9.75"$ [248]

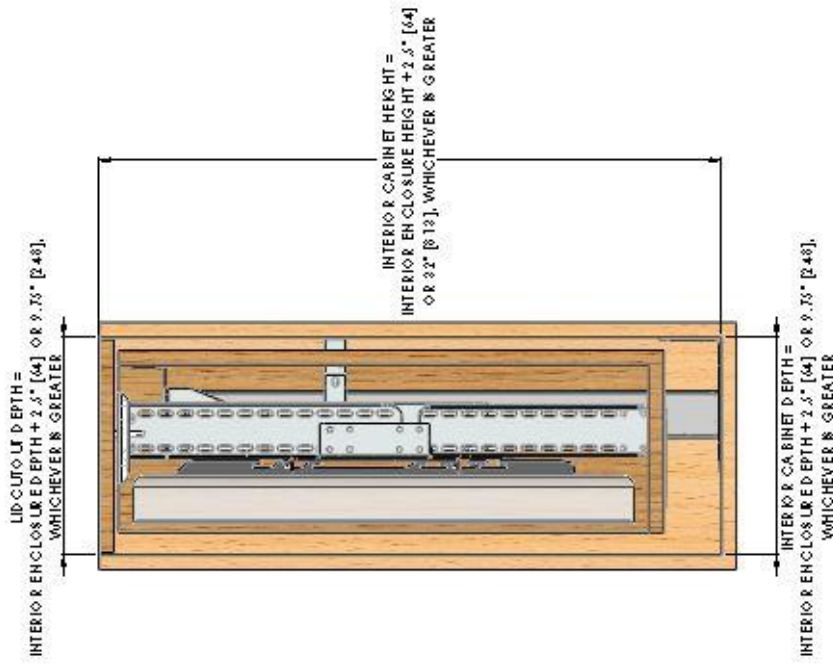
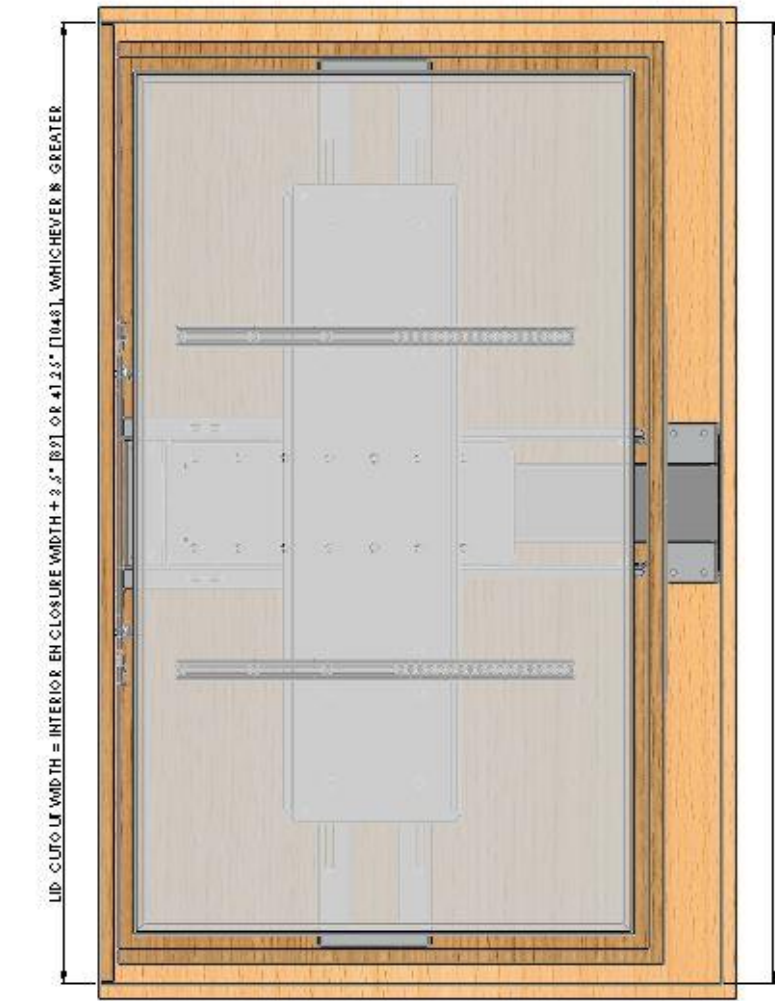

NOTES:

1. THE CABINET BOX AND ENCLOSURE BOX SHOWN IN THE DIAGRAMS FOR REFERENCE ONLY AND THEY ARE NOT PROVIDED WITH THE LIFT SYSTEM
2. FOR CABINET REFERENCE DIMENSIONS SEE PAGE 4 OF THIS DIAGRAM. FOR ENCLOSURE DIMENSIONS SEE PAGES 1 AND 2
3. DIMENSIONAL EQUATIONS SHOWN ON THIS PAGE OF THE DIAGRAM ARE TO BE USED WITH THE DIMENSIONAL EQUATIONS FOUND ON PAGE 1
4. ALL DIMENSIONS SHOWN IN INCHES WITH MILLIMETERS SHOWN IN []
5. INTERIOR CABINET EQUATIONS ARE BASED ON INTERIOR ENCLOSURE DIMENSIONS

NEXUS 21

COPYRIGHT 2017. ALL RIGHTS RESERVED.

MODEL L-50EN DIAGRAM

CABINET REFERENCE DIMENSIONS - PAGE 4 OF 4

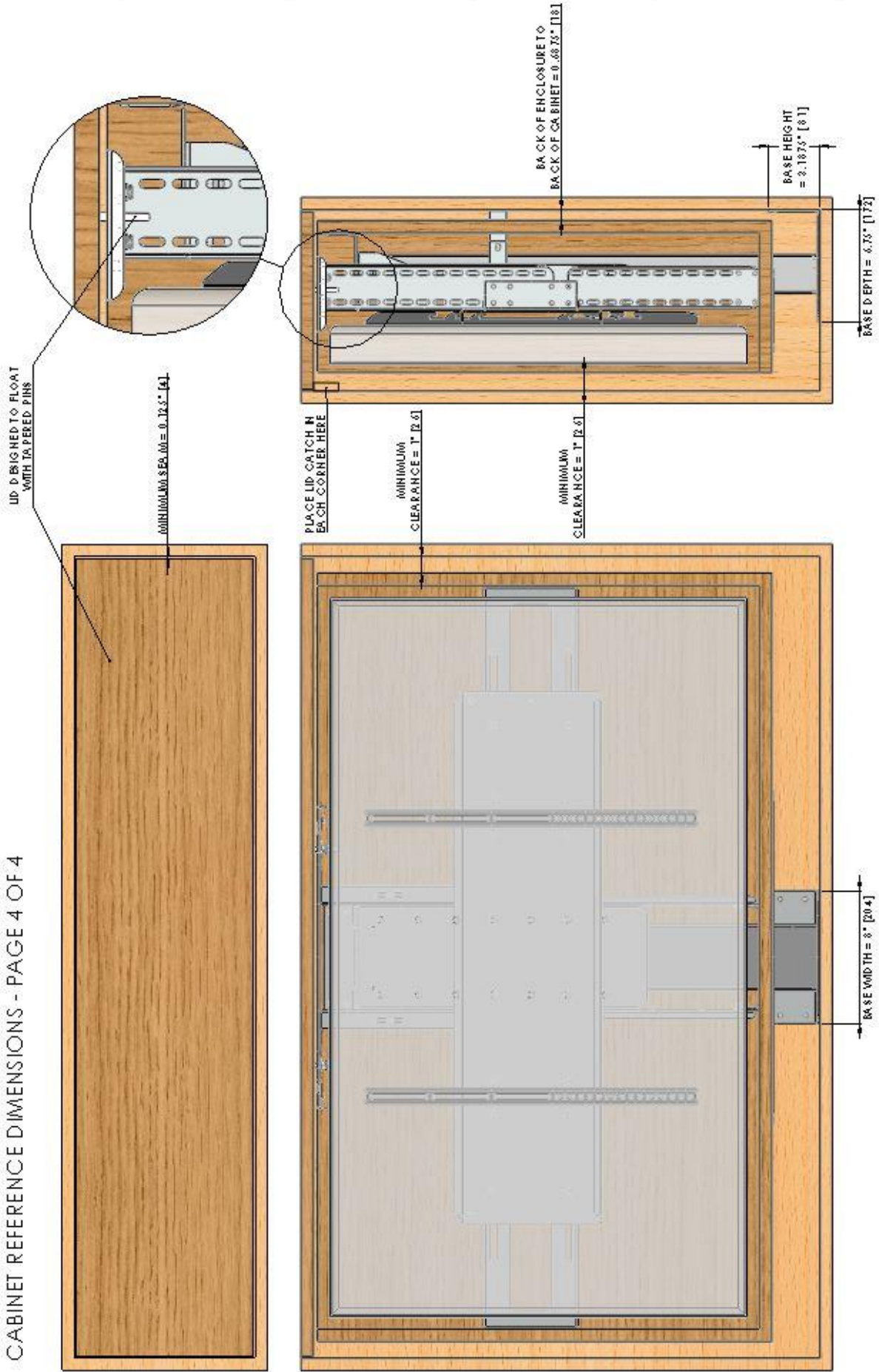

- NOTES:
1. THE LID FOR THIS MODEL IN THE TOP PANEL OF THE ENCLOSURE AND MUST FLOAT USING THE PROVIDED TAPERED PINS.
 2. TAPERED PINS ALLOW LID TO FLOAT WITH THE LIF OF LID CATCHER AND ALLOW THE LID TO SIT FLUSH AFTER THE LIFT RETRACTS.
 3. MINIMUM SEAM CAN BE REDUCED TO 0.0625" [1.6] WITH A 45 DEGREE BEVEL ON THE LID.

NEXUS 21
 © COPYRIGHT 2017. ALL RIGHTS RESERVED.

Contact Closure Integration Info

Connecting the Nexus 21 Lift System to Other Control Systems

Use these instructions if you need to wire the Lift System directly to a Home Control System, like those made by Crestron, AMX, Control 4, RTI, etc. A common term for this method of integration is "connection by contact closure."

Contents of Contact Closure Hardware Pack:

Step 1: Contact Closure Hardware Pack

This pack contains the following parts:

- 1 – *Contact Closure Cable*, RJ-45 to Relays
- 1 – *Height limit Insert*



Contact Closure Cable, RJ-45 to Relays



Height Limit Insert

Step 2: Connecting the Lift System to the Control System

Using the *Contact Closure Cable* to connect the three wires directly to the relays on your control module (see image below). Then connect the RJ-45 plug on the *Contact Closure Cable* to the Nexus 21 system, using either one of the two RJ-45 ports on the side of the Nexus 21 Control Box.

The colored wires function as follows:

BLUE = common (Pin 4 from RJ45) **GREEN** = Extend (Pin 5 from RJ45) **RED** = Retract (Pin 8 from RJ45)

Wire combinations for the relays:

The lift system uses two relays. One for "extend" and one for "retract." The common wire runs between both relays, by using the **BLUE common wire**, together with a jumper wire you supply.

Relay 1 Extend: **BLUE** common wire with **GREEN** normally open.

Relay 2 Retract: **BLUE** common wire (use jumper) with **RED** normally open.



Close-up View of RJ-45 Pins



Step 3: Setting a Height Limit for the Lift System

Begin with the Height Limit Insert UNPLUGGED. Then send the "UP" command from your control system and run the Lift System up to your desired height. Once the Lift System is at the desired height, send the "DOWN" command to stop the lift at the point. Now PLUG the Height Limit Insert into the available RJ45 port on the Nexus 21 Control Box. The Lift will now remember the height and always stop at that point. To change, unplug the Height Limit Insert and repeat Step 3.

For technical support or to ask questions, call Nexus 21 Customer Service, toll-free at (866) 500-5438.

NEXUS 21

TECHNOLOGY IN MOTION

866-500-5438