

Thank you for choosing the AVS APM110. Before beginning installation, please check all parts are included and undamaged. For any parts enquiries, please contact AV Supply Group Ltd on (09) 274 9172 or email to info@avsupply.co.nz

SPECIFICATIONS

- Model:** APM110
Maximum Load: 13.6 kg (30 lbs)
Tilt Range: up to 25° up and 25° down
Swivel Range: up to 360°
Distance from Ceiling: 58.3 cm to 110.8 cm (23.0" to 43.6")

BOX CONTENTS

- Ceiling Plate (x1)
- Mount Arm (x4)
- Mount Body (x1)
- Extension Pipe (x1)
- Mount Hook (x1)
- Instruction Manual (x1)
- Mount Base (x1)
- Hardware Kit (x1)

IMPORTANT SAFETY INSTRUCTIONS

- 1 PRODUCT CARE:** Periodically clean your mount with a dry cloth. Inspect all screws and hardware at regular intervals to ensure that no connections have become loose over time. Re-tighten as needed.
- 2 CAUTION:** Do not use this product for any purpose not explicitly specified by AVS. Improper installation may cause property damage or personal injury. If you do not understand these directions, or have doubts about the safety of the installation, contact AVS Customer Service or call a qualified contractor. AVS is not responsible for damage or injury caused by incorrect mounting, assembly, or use.
- 3 WARNING!** This product contains small items that could be a choking hazard if swallowed. Keep these items away from young children!
- 4** The wall or mounting surface must be capable of supporting the combined weight of the mount and the display; if not, the structure must be reinforced.
- 5** Locate pipes, wires, or any other hazards in the wall where you wish to install.
- 6** Safety gear and proper tools must be used. Failure to do so can result in injury or damage.

- 7** Follow all instructions and recommendations regarding adequate ventilation and suitable locations for mounting your display. Consult the owner's manual for your particular display for more information.
- 8** AV Supply Group (AVS) intend to make this manual accurate and complete. However, AVS makes no claim that the information contained herein covers all details, conditions, or variations. Nor does it provide for every possible contingency in connection with the installation or use of this product. The information contained in this document is subject to change without notice or obligation of any kind. AVS makes no representation of warranty, expressed or implied, regarding the information contained herein. AVS assumes no responsibility for accuracy, completeness or sufficiency of the information contained in this document.

TOOLS REQUIRED

- Phillips Head Screw Driver
- Electric or Portable Drill
- 5 mm (3/16") Drill Bit and Stud Finder for Drywall Installation
- 8 mm (5/16") Masonry Bit for Concrete Installation

HARDWARE KIT

- | | | |
|--------------------------|------------------------|---------------------------|
| (A) Wood Screw (x2) | (G) M6 x 16 Screw (x4) | (M) M6 x 45 Screw (x2) |
| (B) Concrete Anchor (x2) | (H) M6 x 40 Screw (x4) | (N) M6 x 56 Screw (x1) |
| (C) M5 x 14 Screw (x4) | (I) M4 Washer (x4) | (O) M6 Spring Washer (x6) |
| (D) M5 Washer (x4) | (J) S3 Allen Key (x1) | (P) M6 Nut (x6) |
| (E) M4 x 16 Screw (x4) | (K) M6 x 35 Screw (x1) | |
| (F) M4 x 40 Screw (x4) | (L) M6 x 40 Screw (x2) | |

INSTALLATION

Part 1A – Mounting to the Ceiling (Drywall)

IMPORTANT! For safety reasons, this mount must be secured to a wooden ceiling joist. The joist must be capable of supporting the combined weight of the mount and display.

- 1** Use a high quality stud finder to locate a ceiling joist where you wish to install your mount. Mark both edges of the joist to help identify the exact center.
NOTE: You must use the center of the joist to avoid cracking or splitting the wood during installation.
- 2** Place the ceiling plate over the joist and mark two locations for securing the plate to the ceiling.
- 3** Set the ceiling plate aside and drill a 5 mm (3/16") pilot hole at each marked location (see Fig. 1).
- 4** Attach the ceiling plate to the ceiling using the wood screws (A) provided (see Fig. 2).

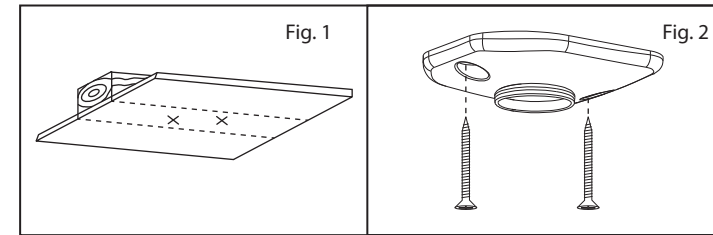

Part 1B – Mounting to the Ceiling (Concrete)

IMPORTANT! For safety reasons, the concrete ceiling must be capable of supporting the combined weight of the mount and the display. The manufacturer takes no responsibility for failure caused by a ceiling of insufficient strength.

- 1** Place the ceiling plate in the desired location and mark two locations for securing it to the ceiling.
- 2** Set the ceiling plate aside and drill an 8 mm (5/16") hole at each marked location. Remove any excess dust from the holes (see Fig. 3).

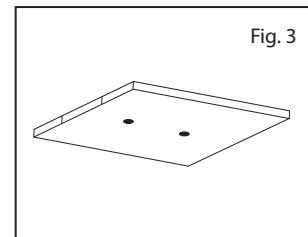

Part 1B – Mounting to the Ceiling (Concrete)(continued)

- Insert a concrete anchor (B) into each hole so that it is flush with the concrete surface (see Fig. 4). A hammer can be used to lightly tap the anchors into place if necessary.
- Attach the ceiling plate to the ceiling using the wood screws (A) provided (see Fig. 2).

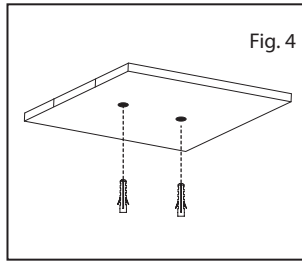

Part 2 – Attaching the Projector to the Mount

- Attach the mount arms to the mount base as shown using the M5 x 14 screws (C) and M5 washers (D) from the kit (see Fig. 5). Attach one mount arm into each slot in the mount base. Leave the screws loose enough so that the arms can be moved when attaching the projector.

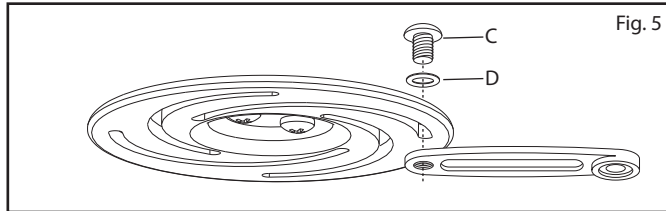

- Attach your projector to the mount arms as shown (see Fig. 6) using the appropriate screw from the hardware kit (E, F, G, or H). If you are using M4 screws (E or F), you will also need to use the M4 washers (I).

NOTE: If you cannot find a screw from the provided hardware kit that fits, consult the manufacturer of your display for the proper size.

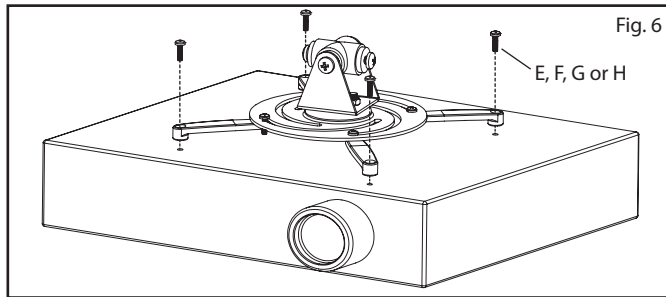

- Tighten the M5 x 14 screws (C) used to attach the arms to the mount base in step 1.

Part 3 – Assembling the Mount

- Screw the mount body into the ceiling plate as shown (see Fig. 7). Tighten the set screw at the top of the mount body using the S3 Allen key (J) from the hardware kit.

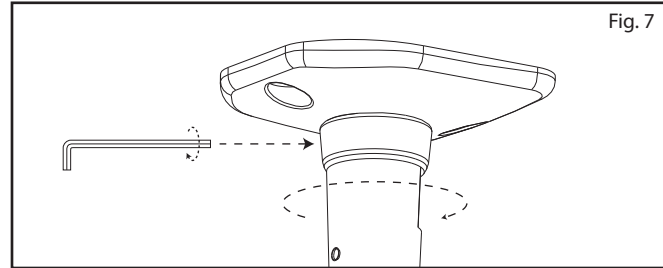

- Attach the wider end of the extension pipe to the mount body using the M6 x 56 screw (N) along with an M6 spring washer (O) and M6 nut (P) (see Fig. 8).

- Adjust the top and middle portions of the extension pipe and secure them using both M6 x 45 screws (M) from the hardware kit along with M6 spring washers (O) and M6 nuts (P) (see Fig. 8).

- Adjust the middle and bottom portions of the extension pipe and secure them using both M6 x 40 screws (L) from the hardware kit along with M6 spring washers (O) and M6 nuts (P) (see Fig. 8).

- Attach the mount hook to the bottom of the extension pipe using the M6 x 35 screw (K) along with an M6 spring washer (O) and M6 nut (P) (see Fig. 9).

- Place the mount base with your projector attached onto the mount hook (see Fig. 10). Tighten the screws on the sides of the mount base to hold it in place.

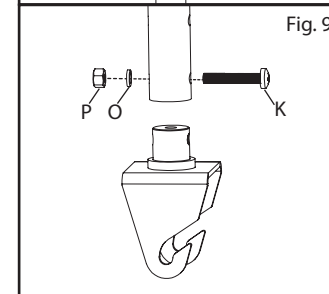
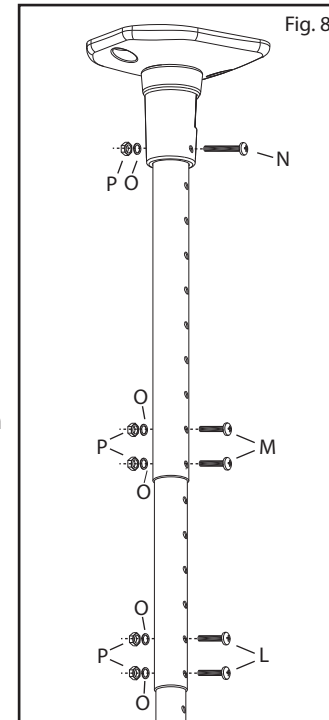

Part 3 – Assembling the Mount (continued)

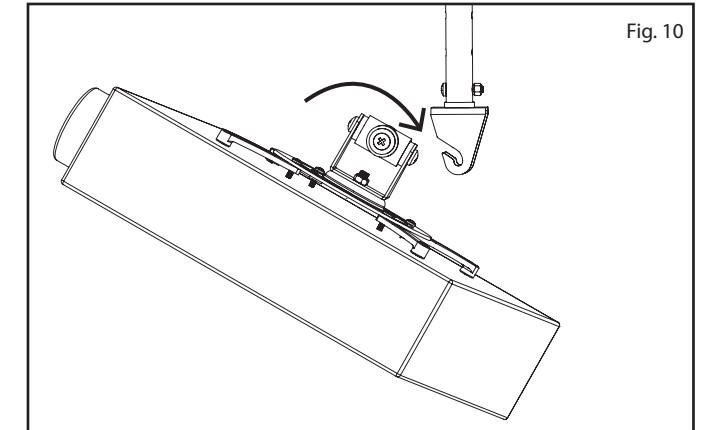

OPERATION AND ADJUSTMENT

- Swivel adjustment can be made by simply turning your projector in the desired direction.
- Tilt adjustments can be made by loosening the screws on both sides of the mount base, moving the projector to the desired angle, and then re-tightening the screws.
- Height adjustments can be made by removing the screws from the extension pipe, moving the projector to the desired height, and replacing the screws.

IMPORTANT! For safety, all bolts provided in the hardware kit must be used at all times.