

SIDE DESK MOUNTING OPTION fits most monitors

INSTRUCTION MANUAL

Thank you for choosing the AVS ADM702. Before beginning installation, please check all parts are included and undamaged. For any parts enquiries, please contact AV Supply Group Ltd on (09) 274 9172 or email to info@avsupply.co.nz

SPECIFICATIONS

Model: ADM702

Display Size: 10"-24"

Maximum Load: 6kg (13.2 lbs)

Mounting Pattern: 100 mm x 100 mm

Tilt Range: 5° up and 15° down

IMPORTANT SAFETY INSTRUCTIONS

- PRODUCT CARE:** Periodically clean your mount with a dry cloth. Inspect all screws and hardware at regular intervals to ensure that no connections have become loose over time. Re-tighten as needed.
- CAUTION:** Do not use this product for any purpose not explicitly specified by AVS. Improper installation may cause property damage or personal injury. If you do not understand these directions, contact AVS Customer Service or call a qualified contractor. AVS is not responsible for damage or injury caused by incorrect mounting, assembly, or use.
- WARNING!** This product contains small items that could be a choking hazard if swallowed. Keep these items away from young children!
- The desk must be capable of supporting the combined weight of the mount and the display; if not, the structure must be reinforced.
- Safety gear and proper tools must be used. Failure to do so can result in injury or damage.

- Follow all instructions and recommendations regarding adequate ventilation and suitable locations for mounting your display. Consult the owner's manual for your particular display for more information.
- AV Supply Group (AVS) intend to make this manual accurate and complete. However, AVS makes no claim that the information contained herein covers all details, conditions, or variations. Nor does it provide for every possible contingency in connection with the installation or use of this product. The information contained in this document is subject to change without notice or obligation of any kind. AVS makes no representation of warranty, expressed or implied, regarding the information contained herein. AVS assumes no responsibility for accuracy, completeness or sufficiency of the information contained in this document.

1	Tube Cover	1PCS
2	Hand handle	1PCS
3	TV plate	1PCS
4	Knob	1PCS
5	Bottom support	1PCS
6	Fixed wreath	1PCS
7	Tube	1PCS
8	Cable cover	1PCS
9	Plastic cover	1PCS

TOOLS REQUIRED



HARDWARE KIT

(A) M4 x 12 Screw (x4)



(B) M5 x 12 Screw (x4)



(C) M5 x 10 Bolt (x1)



(D) 3x3 Allen Key (x1)

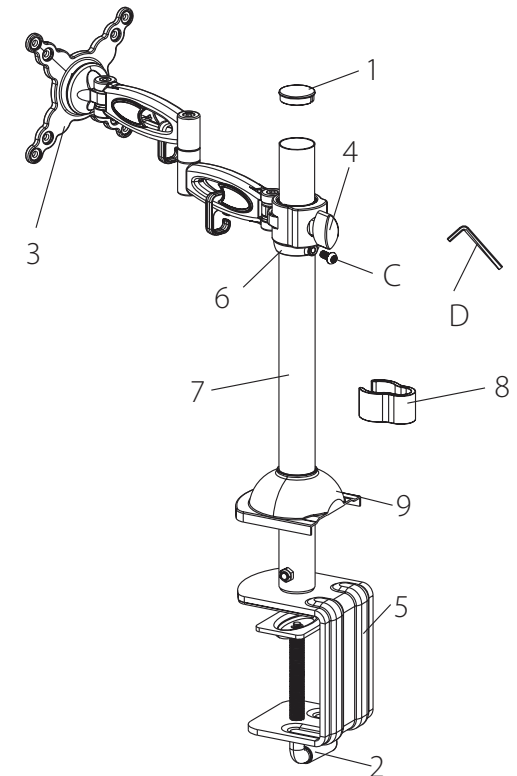

INSTALLATION

Step 1 – Install TV plate and fixed wreath

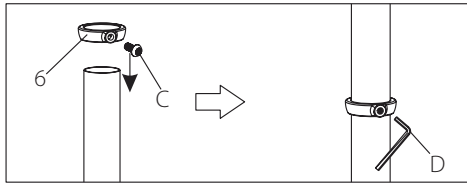

NOTE:

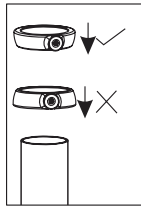

NOTE:

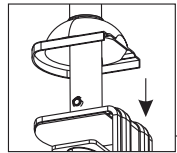
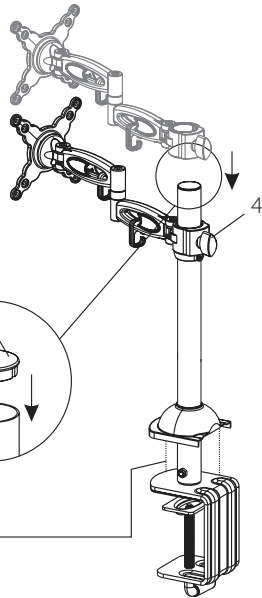
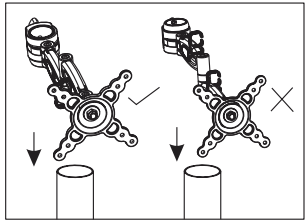

Step 2 – Fitting the bottom support on the desk

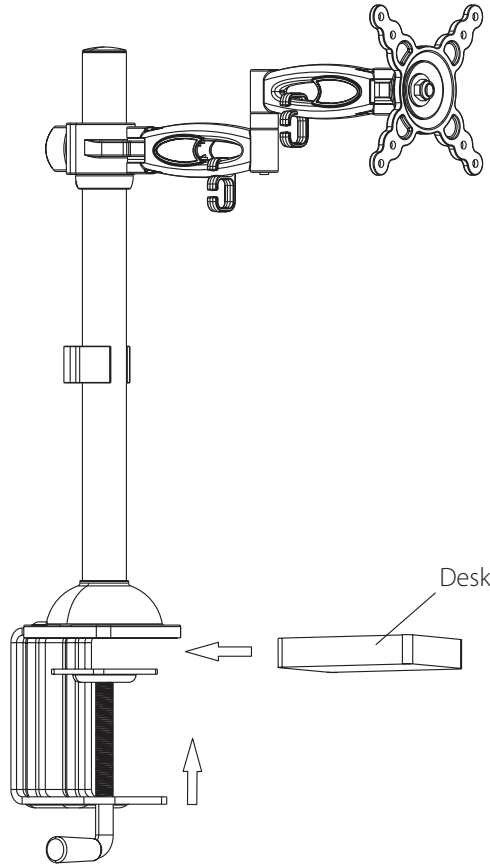

Step 3 – Attaching TV plate to screen

