

# nexus 21

CONCEALMENT SYSTEMS

**TV Lift System Model L-45en  
Installation Instructions**





Below is a parts list describing all of the items included with the Model L-45en Lift System. You may also wish to refer to the diagram shown on "Supplemental Page A" (at the end of this document).

Before beginning assembly and installation, please make sure that you have all items included on the list. If any parts are missing or damaged, please contact Nexus 21. Our contact information is shown at the top of this page.

### Parts List



1. L-45 Lift Column  
(28 1/2" x 7" x 3 3/4")



2. Screen Support Bracket  
(17 1/2" x 6 1/4" x 3 1/2")



3. Base Plate Bracket (2)  
(7 x 5 1/8" x 2")



4. Upper Support Bracket  
(3" x 3 1/2" x 1")



5. Upper Support Bracket Base  
(4 3/4" x 2 1/8" x 7")



6. Screen Back Plate  
(32" x 8 3/4" x 1/2")



7. Lower Support Bracket  
(6 1/4" x 4" x 2 1/2")



8. Top Plate Bracket  
(18 1/4" x 8 1/2" x 1/2")



9. Vertical Mounting Bar (2)  
(20" x 1" x 3/4")

 **NOTE:** Items 6 & 9 are included in the "Nexus 21 Standard TV Mount" package.

## Parts List, continued

---



10. **Control Box**  
(10 ½" x 3 ¾" x 1 ½")



11. **Side Panel Bracket (2)**  
(14" x 1 ¾")



12. **Accessory Mounting Bracket (2)**  
(2 ¼" x 11 ½")



13. **Rear Panel Bracket**  
(6 ¾" x 2" x 3 ½")



14. **Top Support Bracket (2)**  
(14" x 2 ¾" x 1 1/8")



15. **Bottom Panel Bracket**  
(20" x 5" x 3 ¼")

### Cables

- **Motor Cable** – Black cable with white, six-pin plugs. Use this cable to connect the Lift Column to the Control Box (using slot #1 on the Control Box). Three feet long.
- **Power Cable** – Connects Control Box to power outlet. Three feet long.
- **RF Cable (only present if you ordered the RF version of the Lift System)** – Use to connect the RF Receiver to the Control Box. Ends have telephone-style connectors. One foot long.

### Hardware

16. Two (2) -- Screen Locks (In bag labeled PDM-0108 - Located in box with Part #6 and #9)
17. Four (4) -- 6mm x 16mm Button Head Machine Screw
18. Four (4) -- 6mm x 16mm Flat Head Machine Screw
19. Thirty-Two (32) -- 6mm x 10mm Button Head Machine Screw
20. Two (2) -- 1½" x ¼" Steel Threaded Taper Pins (For Floating Top)
21. Twelve (12) -- 3/8 - 16 x ¾" Button Head Machine Screw
22. Eight (8) -- 3/8 Nyloc Hex Nuts
23. Two (2) -- #10 x 1 ¼" Flat Head Wood Screw
24. Forty-Six (46) -- #10 x ¾" Truss Head Wood Screw
25. Four (4) -- #8 x ¾" Flat Head Wood Screw
26. RF Controls or IR Controls (see explanation on page 6)
27. Two (2) -- Allen Wrenches – 4mm and 7/32"
28. Four (4) -- Square Multi Mount Washers
29. Four (4) -- Lid Catch Brackets w/ (8) #10 x ¾" THWS
30. One (1) -- Bag of Assorted TV Mounting Screws

### Wire Management

31. One (1) -- "Snakeskin" Wire Management Sleeve – 4 feet long
32. Four (4) -- Velcro end Ties, for use with Wire Management Snakeskin
33. Four (4) -- Plastic Ties, also for use with Wire Management Snakeskin
34. Four (4) -- Wire Clips



## SAFETY INFORMATION

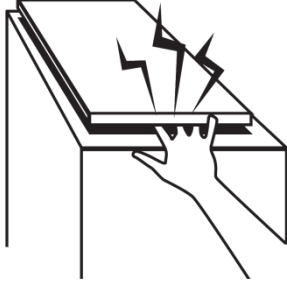

**SEVERE PERSONAL INJURY AND PROPERTY DAMAGE CAN RESULT FROM IMPROPER INSTALLATION OR ASSEMBLY. READ THE FOLLOWING WARNINGS BEFORE BEGINNING:**

<p><b>TV HAZARD</b></p> 	<p><b>CABINET LID HAZARD</b></p> 
<p><b>CAUTION:</b> Avoid contact with the TV and Lift System during operation. Use with caution.</p>	<p><b>CAUTION:</b> The cabinet lid must be installed as described in the instructions, using the Steel Threaded Tapered Pins. Installing the cabinet lid in any other fashion will create hazardous pinch points that can cause serious personal injury.</p>

### WARNINGS:

1. Do not use this product for any application other than those specified by Nexus 21.
2. Do not exceed the weight capacity. This can result in serious personal injury or damage to the equipment. It is the installer's responsibility to ensure that the total combined weight of all attached components does not exceed that of the maximum figure stated.
3. Follow all technical specifications and instructions during the installation.
4. Only use attachments/accessories specified by the manufacturer.
5. Close supervision is necessary when this system is being used by, or near, children, or disabled persons.
6. It is the responsibility of the installer to warn all potential users of the dangers of interfering with the mechanism during operation.
7. Read all technical instructions fully before installation and use. It is the installer's responsibility to ensure that all documentation is passed on the users and read fully before operation.
8. Failure to provide adequate structural strengthening, prior to installation can result in serious personal injury or damage to the equipment. It is the installer's responsibility to ensure the structure to which the Lift System is affixed can support four times the weight of the system.
9. Risk of electric shock. Do not attempt to open the Control Box.
10. To reduce risk of fire or electric shock, do not expose parts to rain or other liquids.
11. Protect the power cord from being walked on or pinched.
12. Keep all documentation.
13. Heed all warnings.
14. Clean only with a dry cloth.
15. Refer all service questions to Nexus 21 if the system does not operate normally.

*Nexus 21 disclaims any liability for modifications, improper installations, or installations over the specified weight range. Nexus 21 will not be liable for any damages arising out of the use of, or inability to use, Nexus 21 products. Nexus 21 bears no responsibility for incidental or consequential damages. This includes, but is not limited to, any labor charges for the servicing of Nexus 21 products performed by anyone other than Nexus 21.*

*Nexus 21 intends to make this and all documentation as accurate as possible. However, Nexus 21 makes no claim that the information contained herein covers all details, conditions or variations, nor does it provide for every possible contingency in connection with the installation or use of this product. The information contained in this document is subject to change without prior notice or obligation of any kind. Nexus 21 makes no representation of warranty, expressed or implied, regarding the information contained herein. Nexus 21 assumes no responsibility for accuracy, completeness or sufficiency of the information contained in this document.*

## Types of Controls for Nexus 21 Lift Systems

All Nexus 21 Lift Systems come standard with a **wireless remote control** and receiver. We offer a choice of two different types of remotes: IR and RF (both of which are explained in detail below). Our standard control type is RF, so unless you specifically requested the IR version when you made your purchase, you probably received the RF controls with this Lift System. The method of installation for each type of remote control is slightly different, so you should now identify which type of remote you have by reading below, and then follow the instructions for that type of remote.

**NOTE:** If you will be using the Lift with a home control system (like the ones made by companies such as Crestron or Control 4) the most common form of control is to WIRE IT DIRECTLY to the relays of your home control system. This direct-wire method is called **Integration by Contact Closure**, and is accomplished by using the Backup Control Switch (Height Limit Switch) that was supplied with the Lift System to connect the Lift to the control unit from your home control system.

### Before You Begin the Installation: Identify Your Control Type

**IR (Infrared)** – This control option allows you to utilize a 3<sup>rd</sup> party universal style remote control to raise and lower the TV Lift. Your universal remote will “learn” the IR codes from the provided IR Handset, which will enable you to control the lift. The universal remote will then communicate with the “eye” located on the IR Receiver via your 3<sup>rd</sup> party emitter (or flasher). Instructions for mounting the IR controls are on page 13. Instructions for setting the TV Lift’s travel limit are on Supplemental Page B.

**NOTE:** If you are NOT planning on using a 3<sup>rd</sup> party Universal Remote, switch to the RF setup. (There is no charge for swapping)

**These are the parts included with IR controls:**



**Contact Closure Hardware**



**IR Receiver**



**IR Handset**



**Height Limit Insert**

**RF (Radio Frequency)** - This system utilizes a wireless remote control handset that sends a radio signal to the RF Receiver. The radio signal can go through cabinet walls and does not require line-of-sight. Instructions for mounting the RF controls are on page 14. Instructions for setting the Lift System travel limit are on Supplemental Page B.

**TIP:** Planning to integrate the TV Lift with your UNIVERSAL REMOTE CONTROL? The RF version of the Nexus 21 controls won’t do it. Switch to IR.

**These are the parts included with RF controls:**



**Backup Switch**



**RF Receiver**



**RF Handset**



**Height Limit Insert**

**Integration by Contact Closure** – To direct-wire the TV Lift controls to a home control system (Crestron, Control 4, AMX, etc.) you will use the Back-up Control Switch (Height Limit Switch). You won’t use any Nexus 21 receiver or handset for this type of control because you will use the handset or control pad that comes with your home control system. **Instructions for setting up the System using Contact Closure are on “Supplemental Page C”.**

## Assembly and Mounting – Things to Think About First

### **SAFETY NOTICE:**



- For proper support, the Lift System MUST NOT be attached to any material that is less than 3/4" thick. This applies to BOTH the back and bottom mounting points.



- The Lift Column is ONLY designed and rated for VERTICAL, NON-INVERTED USE. **DO NOT MOUNT THIS LIFT SYSTEM UPSIDE DOWN or SIDEWAYS (HORIZONTALLY, AS IN A LATERAL MOUNT)!**

### **Space requirements for the L-45en Lift System are as follows:**

Interior Box Depth = TV Depth + 5", or 6.5", whichever is greater.

Interior Box Height = TV Height + "1, Not to Exceed 35" (Exterior Height not to exceed 35.5).

Interior Box Width = TV Width + 1".

Interior Cabinet Depth = Interior Box Depth + 2.375" or 11.25", whichever is greater.

Interior Cabinet Height = Box Height + 2.5", Not to exceed 37"

Interior Cabinet Width = Exterior Box Width plus 1"

Lid Depth = Interior Box Depth + Back Panel Thickness + 1.25" or 8.75 whichever is greater.

Lid Width = Exterior Box Width + 1"



**IMPORTANT NOTE:** The TV must be mounted **as high up as possible inside the cabinet**, so that when the Lift is in the fully "DOWN" position (fully retracted), the top of the TV will be just underneath the lid of the cabinet.

## About the Cabinet Lid (Cabinet Top)

### **SAFETY NOTICE:**



- **WARNING! YOU MUST NOT DIRECTLY SCREW THE CABINET LID (TOP) TO THE LIFT SYSTEM!! THIS CREATES HAZARDOUS "PINCH POINTS" AND MAY AFFECT THE OPERATION OF THE LIFT OR CAUSE DAMAGE TO THE CABINET TOP.**



- For floating lids, **DO NOT USE SCREWS to attach the lid to the Lift System.** Instead, use the "Threaded Taper Pins". This will keep the lid firmly in place, but will also allow it to **separate from the lift system** if anything (like a finger) gets in the way when the TV lowers.

### **Which Lid Style Will You Use? (There are 3 Different Styles)**

**Floating Lid (Floating Top)** – The whole top of the cabinet sits on top of the Lift System and raises/lowers with the TV. This is the standard Installation method, using the Top Plate (part #8) and Threaded Taper Pins.

**Cut-Out Floating Lid (Top)** – You will "cut out" part of your cabinet top, customizing it to the size of your TV. That cut-out lid then sits on top of the Lift System and raises/lowers with the TV. This method uses the Top Plate (part #8) and Threaded Taper Pins (Part #20), but you must set up a "catch" for the cut-out lid so that when the TV lowers, the lid stops level with the rest of your cabinet top (like a manhole cover).

**Hinged-Lid (Hinged-Top)** – Not Compatible with the L-45en Lift System.

## You Are Ready to Begin

Please perform the following steps, in order:

**Step 1: Inventory the Parts List.** Carefully inspect all items, making sure you have everything in the Parts List on page 1. Be sure to open the Nexus 21 TV Mount carton that includes parts #6, #9 and #17.

**Step 2: Attach both *Base Plates* to the bottom of the *Lift Column*.** Using (4) 6mm x 10mm *Button Head Machine Screws* (BHMS), attach (1) *Base Plate* to each side of the base of the *Lift Column* (two screws per side). **Do Not Over Tighten.**



**Step 3: Attach the *Lower Support Bracket*.** Using (2) 6mm x 10mm *Button Head Machine Screws* (BHMS) attach the *Lower Support Bracket* to the rear of the base of the *Lift Column*. **Do Not Over Tighten.**





**Step 4a: Attach the *Upper Support Bracket*.** Slide the *Upper Support Bracket* around the outer profile. Make sure the *Upper Support Bracket* sits just above the Nexus 21 label for optimal support.



**Step 4b: Attaching the *Upper Support Bracket Base (Part #5)*.** Using (2) 6mm x 10mm Button Head Machine Screws (BHMS) attach the *Upper Support Bracket Base* to the *Upper Support Bracket*. Make sure to hold the *Upper Support Bracket Base* firmly against *Lift Column* while tightening the screws, to ensure there is no lateral movement.



**Step 5: Attach the *Screen Support (Part #2)* and *Rear Panel Bracket (Part #13)* to the top of the *Lift Column*.** Align the four threaded holes on top of the *Lift Column* with the four countersunk holes on the *Screen Support* and the four center holes of the *Rear Panel Bracket*. Using (4) 6mm x 16mm BHMS fasten both brackets to the top of the *Lift Column*.



**Step 6: Attach the *Bottom Panel Bracket (Part # 14)* to the *Accessory Mounting Brackets (Part #12)*.** Using (8) 6mm x 10mm BHMS Screws (4 screws per bracket) fasten both *Accessory Mounting Brackets* to the *Bottom Panel Bracket*. **NOTE:** Make sure you use the lower most four holes on the *Accessory Mounting Brackets*.

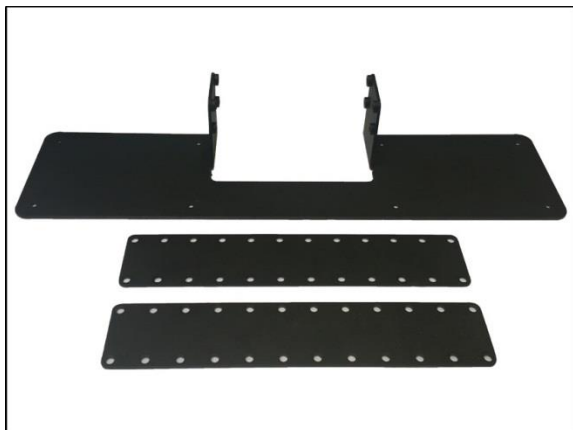

**Step 6 Continued:**



**Step 7: Attach the assembled *Lower Panel Bracket* to the *Screen Support Bracket*. Using (8) 6mm x 10mm BHMS Screws (4 screws per side), fasten the *Lower Panel Bracket* to the *Screen Support Bracket* using the 3<sup>rd</sup> and 4<sup>th</sup> holes from the top of the *Accessory Mounting Brackets*.**



**Step 8:** Place *Lift Column* inside cabinet and make sure to center the *Lift Column* from left to right.

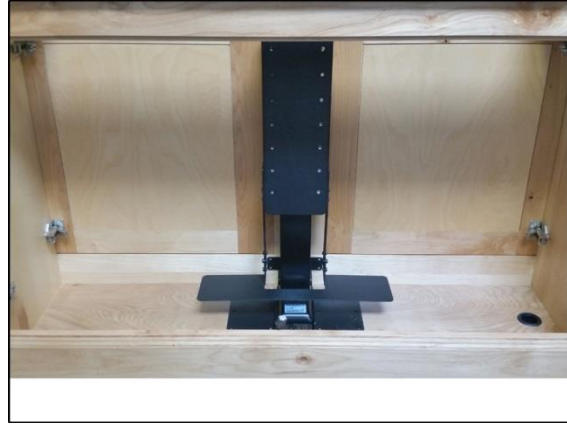

**Step 9:** Mount the *Control Box* and controls to the wall at a nearby accessible location: Using (2) #10 x 1 3/4" FHWS mount the *Control Box* to the wall. Using (2) #8 x 3/4" THWS mount the *Wired Back Up Switch*. If you ordered *IR Controls*, then you will use (2) #8 x 3/4" FHWS to mount the *IR Receiver*. If you ordered *RF Controls*, then you will use (2) #6 x 3/4" RHWS to mount the *RF Receiver*.



**Step 10:** Please refer to the IR Controls Wiring Diagram on the following page, if you ordered RF Controls continue to page 13. Ensure that the motor cable is connected to port #1. The lift will not operate if motor the cable is connected to ports #2 or #3.

**IF YOU HAVE IR CONTROLS, USE THIS DIAGRAM** (for RF Controls, see the following page)

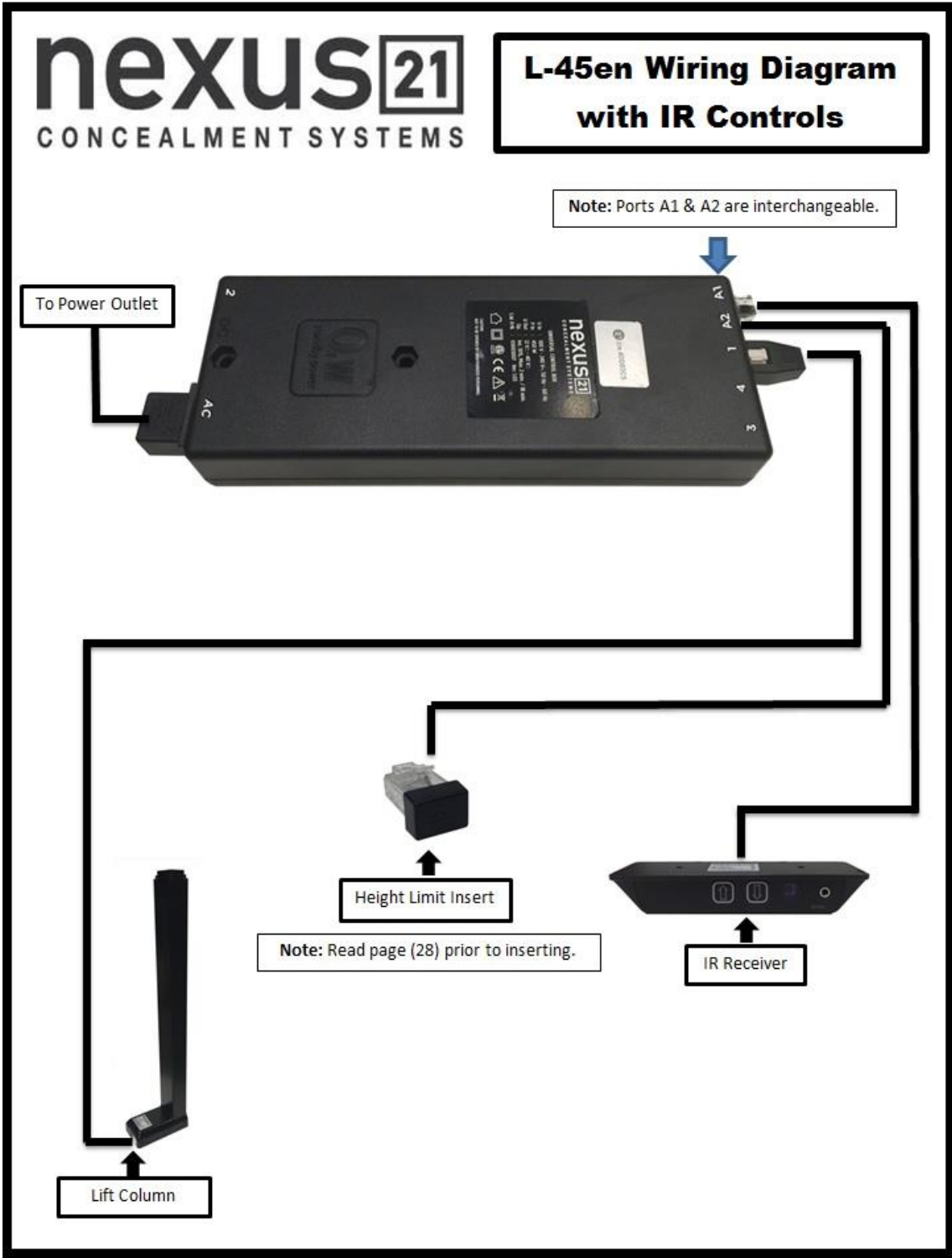

Once you have connected the controls, test the Lift Column as follows:  
First, you need to “initialize” the Lift System. If you have already raised the Lift Column, lower it again, since this step must be performed in the “down” position. Find the Wired Backup Switch, which has two triangle-shaped buttons - an UP (with raised dot) and a DOWN. Press the DOWN button and HOLD IT DOWN for approximately 5 seconds. You should see a slight movement in the Lift Column. If you do not see the movement, release the Down button, and repeat the process - press and hold the Down button again for 5 seconds. Once you have seen the slight movement, the Lift System is now functional. Test it by pressing the Up button (no need to hold the Up button) and the lift will go up. You may let it go to the top, or stop it at any time by pressing the Down button.

IF YOU HAVE RF CONTROLS, USE THIS DIAGRAM (for IR Controls, see the previous page)

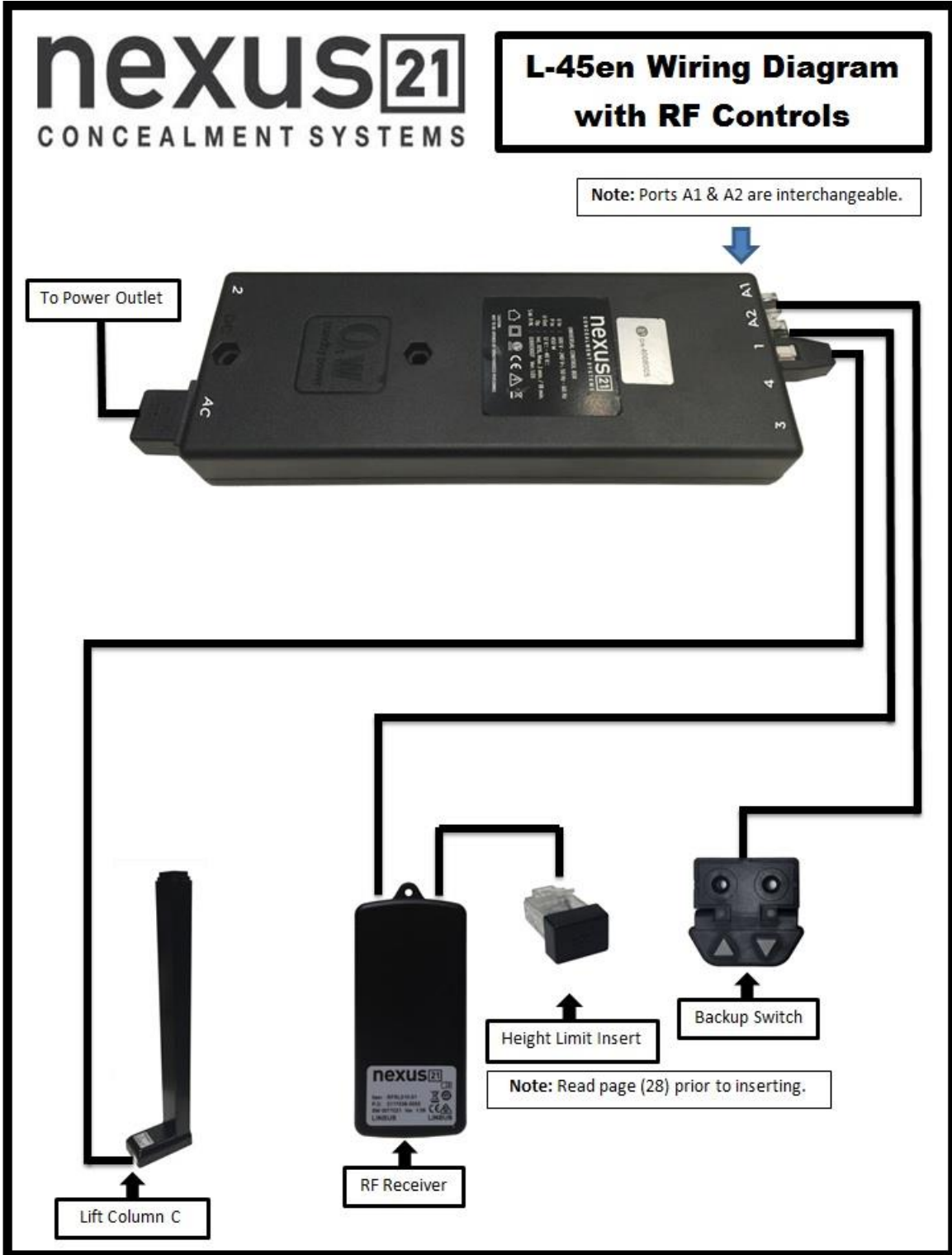

Once you have connected the controls, test the Lift Column as follows:

First, you need to "initialize" the Lift System. If you have already raised the Lift Column, lower it again, since this step must be performed in the "down" position. Find the Wired Backup Switch, which has two triangle-shaped buttons - an UP (with raised dot) and a DOWN. Press the DOWN button and HOLD IT DOWN for approximately 5 seconds. You should see a slight movement in the Lift Column. If you do not see the movement, release the Down button, and repeat the process - press and hold the Down button again for 5 seconds. Once you have seen the slight movement, the Lift System is now functional. Test it by pressing the Up button (no need to hold the Up button) and the lift will go up. You may let it go to the top, or stop it at any time by pressing the Down button.



**Step 11: Attach the *Upper Rear Support Bracket* to the rear panel of your cabinet.** Fully extend the *Lift Column*. Using (2) #10 x 3/4" THWS Screws fasten the *Upper Rear Support Bracket* to the rear panel of the cabinet.

**Note:** Make sure to center the *Lift Column* from left to right.



**Step 12: Attach the *Lower Rear Support Bracket* to the rear panel of your cabinet.** Using (4) #10 x 3/4" THWS Screws fasten the *Lower Rear Support Bracket* to the rear panel of the cabinet.



**Step 13: Attach both *Base Plate Brackets* to the base of the cabinet.** Using (12) #10 x 3/4" THWS Screws (6 screws per side) fasten both *Base Plate Brackets* to the base of the cabinet.



**NOTE:** Step 14a - 14c assumes all joints are Butt Joints when determining the dimensions for each Panel.

**Step 14a: Determining Interior Box dimensions.** Lower the *Lift Column* to the fully retracted position. Measure the distance from the top of the *Bottom Panel Bracket* to the “Lip” or “Corner Catches” the lid will rest on when the lift is in the fully retracted position. This measurement will determine the height of the rear and side panel dimension. Measure the width of the opening and subtract  $\frac{1}{2}$ ” plus your material thickness x 2, which will give you the rear panel width measurement.

**NOTE:** You will need to cut a  $\frac{1}{2}$ ” thick slot, 26 inches up the rear panel, starting from the bottom up. This will allow the *Upper Rear Support Bracket* to slide into, when the lift is fully retracted.

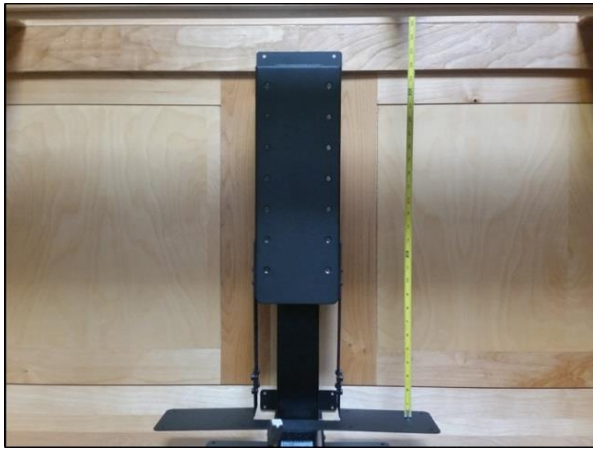

**Step 14b: Determine the side panel dimensions.** Measure the lid opening depth from front to back, subtract your rear panel material thickness plus  $\frac{1}{2}$ ” from the lid opening depth measurement. This will determine the width measurement for both side panels. You will use the height measurement from the previous step as the height measurement for both side panels.

**Step 14c: Determine the bottom panel dimensions.** The bottom panel should be the same width as the rear panel, which was determined in Step 14a. Measure the depth of the lid opening and subtract  $\frac{1}{2}$ ” plus the material thickness. This will give you the depth of the bottom panel. **NOTE:** You will need to cut a 7.5” x 5.5” rectangle in the center of the bottom panel, on the back edge of the bottom panel. This cut will allow you to slide your Interior Box down over the *Screen Support Bracket*.

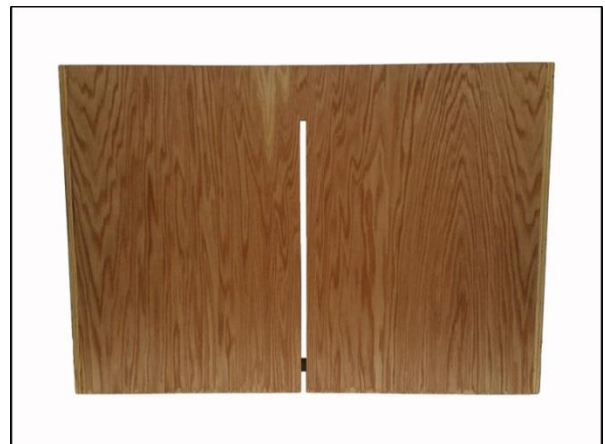



**Step 15a: Attach the constructed Interior Box to the lift system.** Raise the lift system, so the *Bottom Panel Bracket* is flush with the top of the cabinet. Slide the Interior Box over the *Screen Support Bracket* and allow the Interior Box to rest on the *Bottom Panel Bracket*.



**Step 15b: Fasten the Rear Panel Bracket to the rear panel of the Interior Box.** Using (4) #10 x 3/4" THWS Screws fasten the Interior Box to the *Rear Panel Bracket*. **NOTE:** Make sure to center the Interior Box within the opening of the cabinet on all sides.



**Step 16: Test Run the Lift System.** Run the lift up and down a few times to make sure the *Upper Rear Support Bracket* does not rub or bind up on the 1/2" slot in the rear panel of the Interior Box.

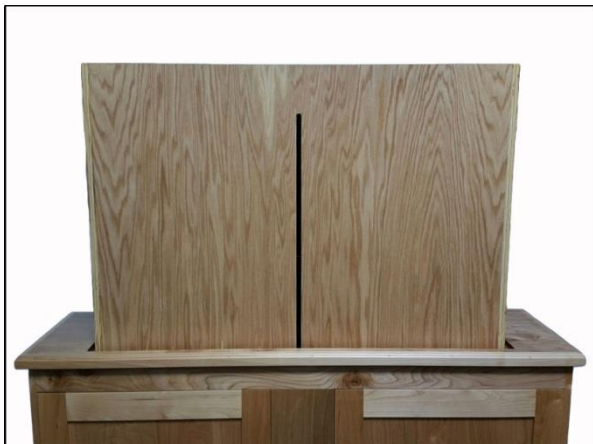

**Step 17: Attach the *Bottom Panel Bracket* to the bottom panel of the Interior Box.** Using (8) #10 x ¼" THWS Screws fasten the *Bottom Panel Bracket* the bottom side of the Interior Box.



**Step 18: Attach the *Screen Back Plate (Part #6)* to the *Screen Support*.** Using (4) 3/8" x 16 BHMS Screws fasten the *Screen Back Plate* to the *Screen Support*. Make sure to center the *Screen Back Plate* on the *Screen Support*.



**Step 19a: Attach the *Side Panel Brackets* to the *Screen Back Plate*.** Using the four outer holes on both side of the *Screen Back Plate* use (8) 3/8" x 16 x ¼" BHMS Screws and (8) 3/8" x 16 x ¼" Hex Nyloc Nuts (4 screws and nuts per side) to fasten *both Side Panel Brackets* to the *Screen Back Plate*. **NOTE:** For larger Interior Boxes, only two of the four 3/8" BHMS holes will be useable.

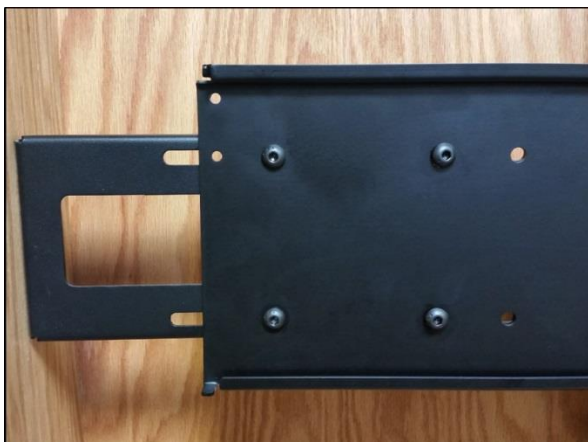



**Step 19b: Attach the *Side Panel Brackets* to the side panels of the Interior Box.** Using (16) #10 x ¼" THWS Screws (8 screws per bracket) fasten both *Side Panel Brackets* to each side panel of the Interior Box.



**Step 20: Attach the *Top Support Brackets* (Part #14) to the *Screen Support Bracket*.** Using (8) 6mm x 10mm BHMS Screws (4 Screws per bracket) fasten the both *Top Support Brackets* to the both sides of the *Screen Support Bracket*. **NOTE:** Make sure to position the *Top Support Brackets* so the top of the brackets are a ¼" – ½" below the top edge of the Interior Box. There are two sets of PEM Nuts on the sides of the *Screen Support Bracket*, which will give you ½" adjustments.

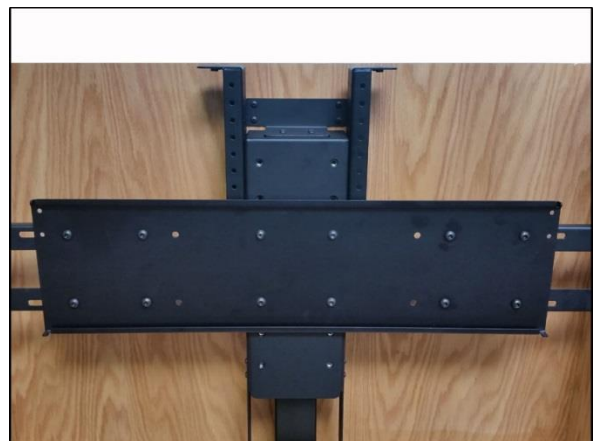

The *Top Plate Bracket* (Part #8) is a 5-part plate (one Main Plate, two Extensions and two Fine-tuning Plates) that allows you to adjust the depth and position of the plate relative to the *Threaded Tapered Pins* (Steps 22-27). The *Top Plate Bracket* comes pre-assembled in a semi-retracted configuration. If you need to expand the depth of the plate to accommodate a deeper cabinet lid, remove the flat head machine screws from the Extensions, move them to the depth you need, and re-insert the machine screws. Fully retracted, the *Top Plate Bracket* has a depth of 6 ½", and can be adjusted to 7 ½" and 8 ½" with the Extensions on either end of the plate. (See Photo Below)



**Step 21: Attach the *Top Plate Bracket* (Part #8) to both *Top Support Brackets*.** Using (4) 6mm x 16mm FHMS Screws attach the *Top Plate Bracket* to both *Top Support Brackets* using the four outermost countersunk holes.



**NOTE: Do not bolt/screw the Lid to the Top Plate.** Use the provided *Tapered Pins* to attach the Lid to the lift system. The *Tapered Pins* allow the lid to lift away when there is an obstruction. See the following page for further details.

## Installing the Tapered Pins in the Floating Lid

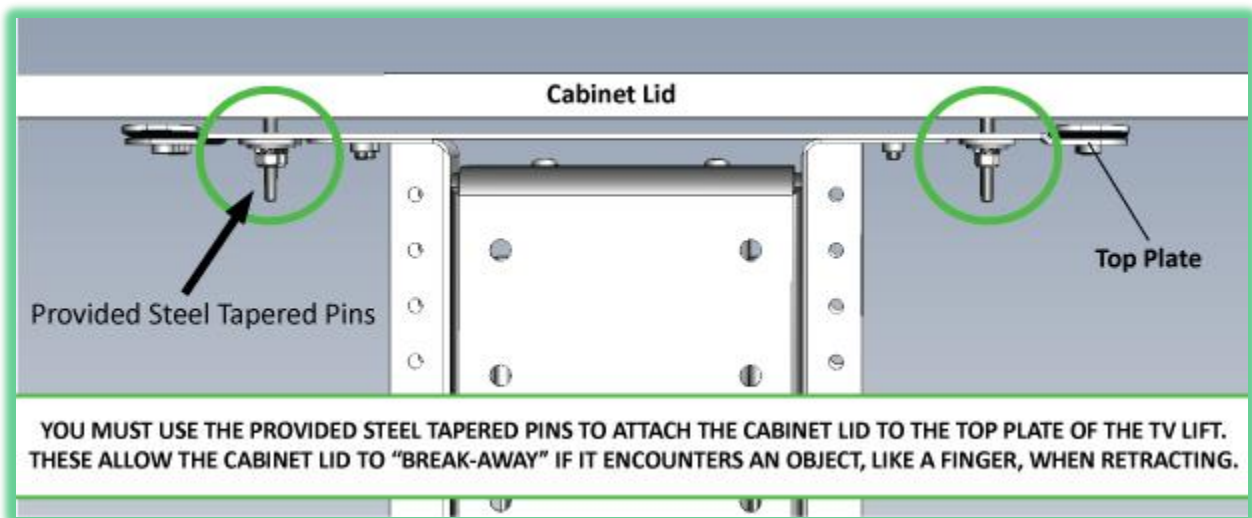

### **What Are the Tapered Pins, and Why Use Them?**

The two 1½" x ¼" *Steel Threaded Tapered Pins* are used IN PLACE OF SCREWS to hold your cabinet top (lid) in place on the Lift System *Top Plate Bracket* (Part #8). The *Tapered Pins* will keep your lid firmly in place, but will also allow it to separate from the lift system if anything (like a finger) gets in the way when the TV lowers. [See Safety Notice above. Please do NOT use screws with your cabinet lid.](#)

### **Before You Install the Tapered Pins, Here is a Reminder of the Two Types of Floating Lids (Floating Tops):**

**Floating Lid (Floating Top)** – The whole top of the cabinet sits on top of the Lift System and raises/lowers with the TV.

**Cut-Out Floating Lid (Top)** – This option assumes that you have "cut out" part of your cabinet top, customizing it to the size of your TV. That cut-out lid then sits on the *Top Plate Bracket* of the Lift System, held in place by the *Taper Pins*, and raises/lowers with the TV. You must set up a "catch" for the Cut-Out Lid so that when the TV lowers, the Lid stops level with the rest of your cabinet top (like a manhole cover), and the Lift System continues down a little further into the cabinet (no more than ¼" to ½"). In this way, when the Lift System is fully retracted, the Cut-Out Lid will always be level, and the *Top Plate Bracket* of the Lift System will always be positioned just below the Lid. Since the Lid and the *Top Plate Bracket* are slightly separated from one another, but still very close, the *Taper Pins* (which are 1½" long) will still be hanging down through the holes in the *Top Plate* so when the Lift System moves, everything is properly aligned and the Lid rides smoothly up and down.



**How to Install the Tapered Pins:**

You will be screwing the *Tapered Pins* into the underside of your cabinet lid, and they will hang down and drop into the two “Nesting Holes” in the *Top Plate Bracket* (Part #8).

**Step 22: Before installing the Tapered Pins, position the Cabinet Lid.** With the TV and the Lift System in the fully retracted position, set the Cabinet Lid in place. It will not be attached at this point, so move it around on the *Top Plate Bracket*, making sure it fits centered in the cabinet opening.

**Step 23: Run the Lift System up and down with the Cabinet Lid sitting on top, but not attached.** Without bumping the Cabinet Lid out of place, use the Remote Control Handset to send the Lift System up and down. Make sure that when the Lift comes down, the Cabinet Lid drops into the proper position relative to your cabinet opening. **NOTE:** You may want to temporarily tape your lid, to prevent the lid from shifting.



**Step 24: Mark the spots for the Tapered Pins.** Again, without bumping the Cabinet Lid out of place, run the Lift System all the way up, with the Cabinet Lid sitting on top. Look at the underside of the *Top Plate Bracket*, find the two “Nesting Holes” and use a felt-tip pen or a pencil to mark the position of the holes on the underside surface of the Cabinet Lid. **NOTE:** Make sure the nuts on the bottom side of the *Top Plate Bracket* are hand tight and centered before you mark your lid.





**Step 25: Remove Cabinet Lid and drill two holes in the marked positions.** Use a 7/32" drill bit to drill two holes, 1/2" deep, in the underside of the Cabinet Top where you have marked.



**Step 26: Using a Phillips head screw driver (not provided) screw each Tapered Pin into the holes drilled in step 25.**



Tapered Pins

**Step 27: Place the Cabinet Lid onto the Lift System.** Align the Tapered Pins with the 2 holes in the Top Plate Bracket and put the Lid on. Tighten the nuts on the underside of the hole where the Tapered Pins pass through the Top Plate.



**NOTE:** You will have a 1/4" tolerance (in all directions) for the placement of the Tapered Pins into your cabinet lid. There are a set of nuts on the underside of the Top Plate that allow you to adjust the position of the hole that the Tapered Pins will pass through to secure the cabinet lid to the Top Plate. If you happen to position the Tapered Pins a few millimeters off from your intended position, you can still make adjustments to fit properly.

## Mounting the TV to the Lift

**A**

Flat/Unobstructed Back

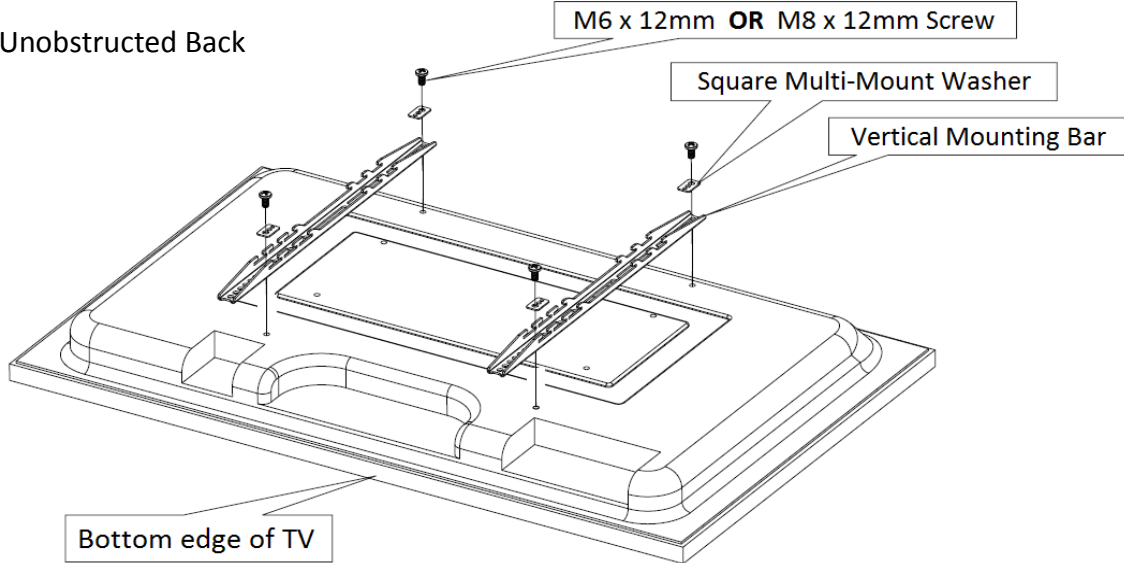

Diagram "A" installation procedure:

- 1) Place the flat screen TV face down on a protected surface.
- 2) Position the Vertical Mounting Bars equidistant from the bottom and top of the TV, with the slots facing toward the top of the TV.
- 3) Using the four (4) Square Multi-Mount washers and the TV mounting screws selected from the bag, attach and tighten the hardware. **DO NOT OVERTIGHTEN HARDWARE. DAMAGE TO TV MAY RESULT.**

**B**

Irregular/Obstructed Back

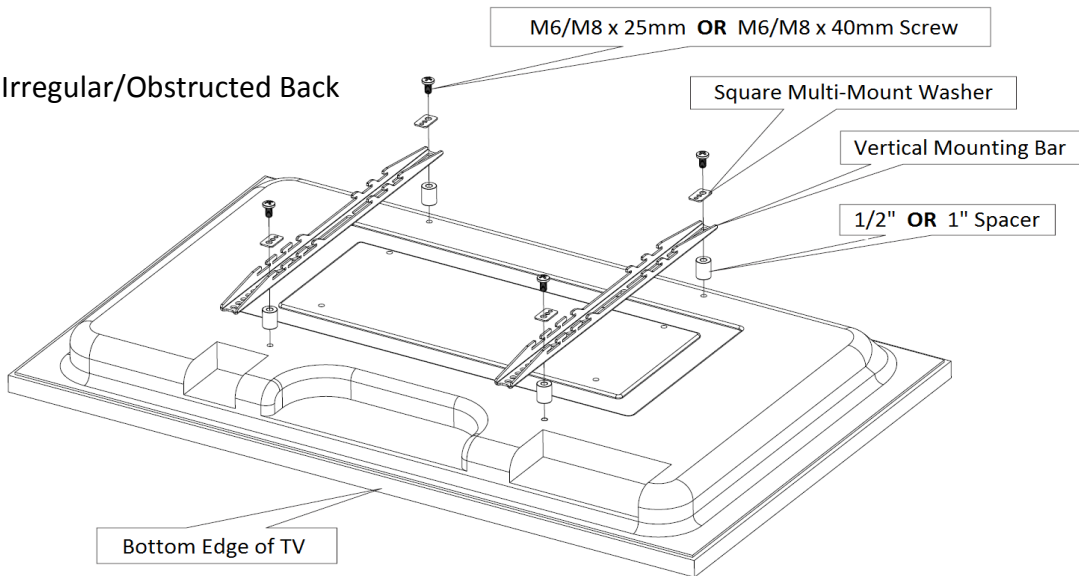

Diagram "B" installation procedure:

- 1) Place the flat screen TV face down on a protected surface.
- 2) Position the Vertical Mounting Bars equidistant from the bottom and top of the TV, with the slots facing toward the top of the TV.
- 3) Using the four (4) spacers needed, (4) Square Multi-Mount washers and the TV mounting screws selected from the bag, attach and tighten the hardware. The hardware will be used in this order (as shown in the diagram above): TV, Spacers, Vertical Mounting Bars, Square Multi-Mount Washers, TV Mounting Screws.

**DO NOT OVERTIGHTEN HARDWARE. DAMAGE TO TV MAY RESULT.**



**Step 28: Attach the *Vertical Mounting Bars (Part #9)* to the TV.** Before you begin, hand thread screws (found in bag labeled “TV Mounting Screws/Spacers”) into the threaded inserts on the back of your TV to determine the correct screw diameter (M6 or M8). The length of the screw required will depend on whether the TV has a flat/unobstructed or irregular/obstructed back. Follow diagram “A” for TV’s with flat/unobstructed back. Use diagram “B” for TV’s with irregular/obstructed back. The diagrams can be found on the previous page.



**Step 29: Mount the TV (with the *Vertical Mounting Bars* attached) to the *Screen Back Plate*.** Each *Vertical Mounting Bar* has “hooks” on either end that allow the bars to “hang” on the *Screen Back Plate*. Lift the TV onto the *Screen Back Plate*. Center the TV. Be sure that both the upper and lower set of “hooks” fully engages with the *Screen Back Plate*.



**Step 30: Insert the *Screen Locks* into both *Vertical Mounting Bars*.** The *Screen Locks* will be placed into the lower “hook” that is just below the *Screen Back Plate*.

**Step 31: Using a Phillips head screwdriver, tighten both *Screen Lock Screws* into the underside of the *Screen Back Plate*.** This will lock your TV onto the TV Lift. You have now successfully attached your TV.



**Step 32: Do a final wire management check.** Test operate the Lift and be sure that all wires are clear of the Lift System, so they do not get “hung up” when the TV is moving either up or down.

**Congratulations your L-45en Lift System is now completed!**

# L-45 BOX ENCLOSURE INSTALLATION GUIDE

## PAGE 1: BOX DIMENSIONS

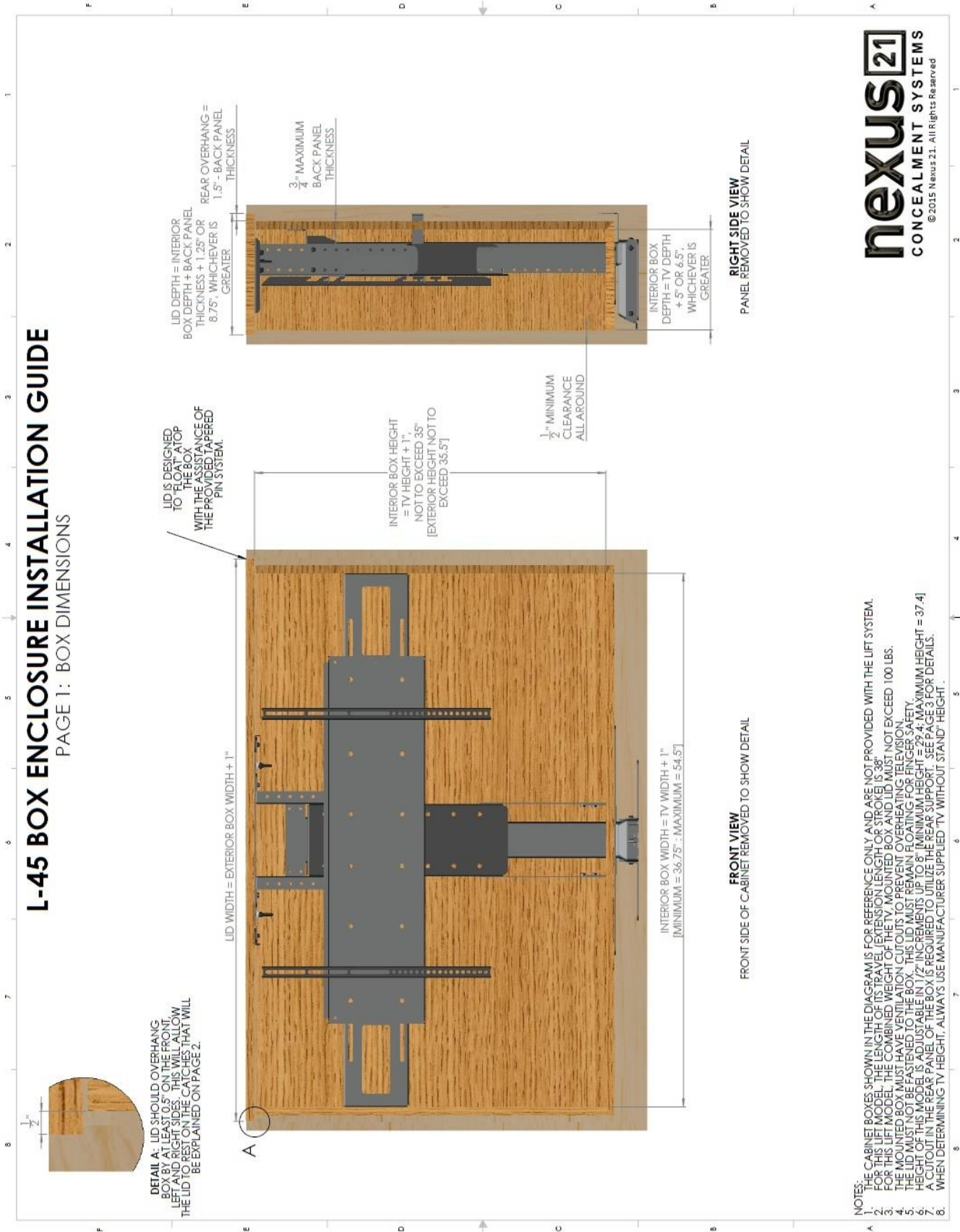

- NOTES:
1. THE CABINET BOXES SHOWN IN THE DIAGRAM IS FOR REFERENCE ONLY AND ARE NOT PROVIDED WITH THE LIFT SYSTEM.
  2. FOR THIS LIFT MODEL, THE LENGTH OF ITS TRAVEL (EXTENSION LENGTH OR STROKE) IS 38".
  3. FOR THIS LIFT MODEL, THE COMBINED WEIGHT OF THE TV, MOUNTED BOX AND LID MUST NOT EXCEED 100 LBS.
  4. THE LID MUST BE INSTALLED TO THE FRONT OF THE TV. THIS DOES NOT PREVENT OPENING THE LID FOR SERVICE.
  5. THE LID MUST BE INSTALLED TO THE FRONT OF THE TV. THIS DOES NOT PREVENT OPENING THE LID FOR SERVICE.
  6. HEIGHT OF THIS MODEL IS ADJUSTABLE IN 1/2" INCREMENTS UP TO 8". MINIMUM HEIGHT = 22.4" MAXIMUM HEIGHT = 37.4"
  7. A "CUTOUT" IN THE REAR PANEL OF THE BOX IS REQUIRED TO UTILIZE THE REAR SUPPORT. SEE PAGE 3 FOR DETAILS.
  8. WHEN DETERMINING TV HEIGHT, ALWAYS USE MANUFACTURER SUPPLIED TV WITHOUT STAND HEIGHT.

**L-45 BOX ENCLOSURE INSTALLATION GUIDE**  
PAGE 2: CABINET DIMENSIONS

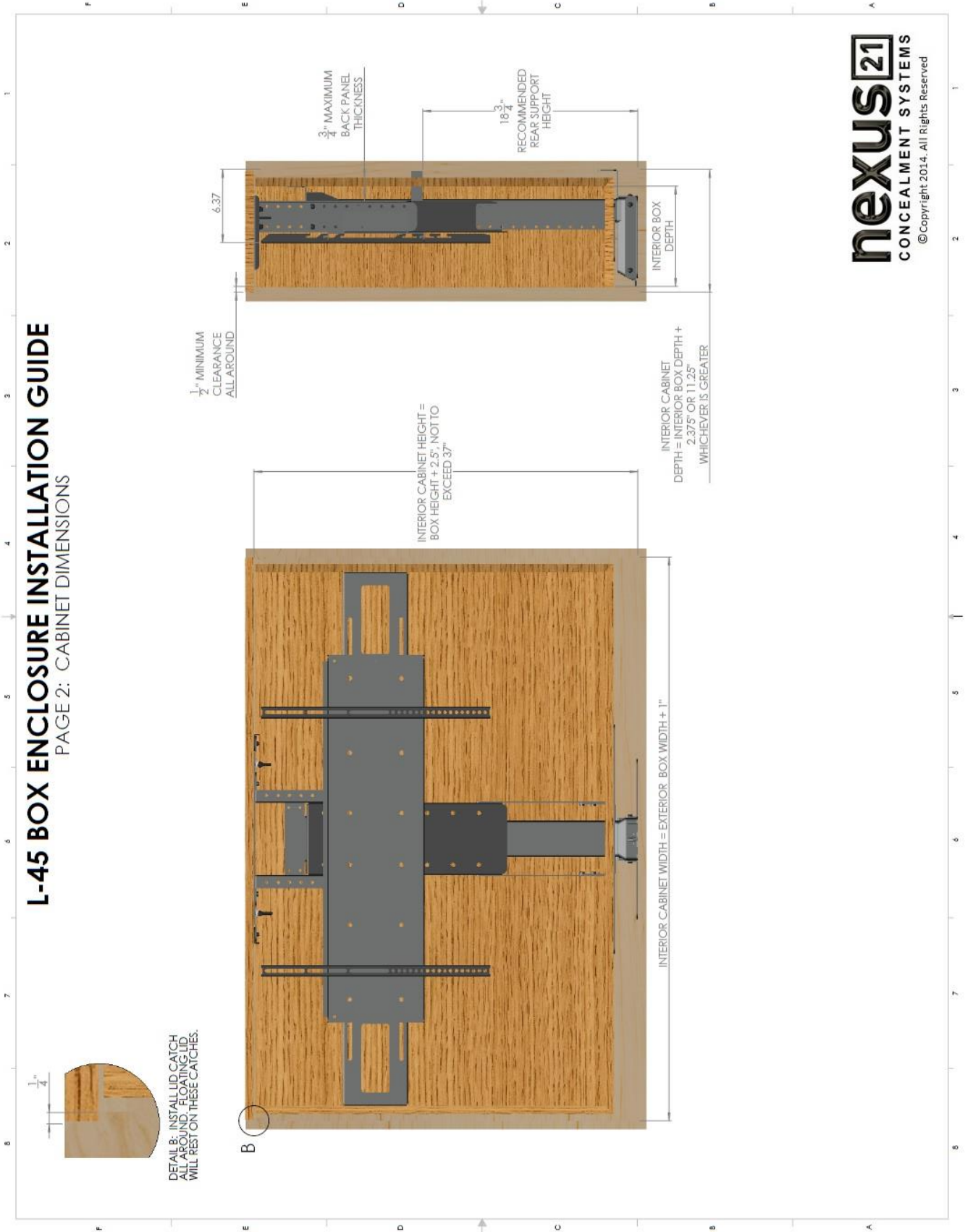



## Supplemental Page B: Setting a Height Limit

Please follow this procedure if you would like to limit the distance that your TV Lift extends.

### To set your Travel Limit with IR Controls:

If you want the lift system to always go to its full extension, do NOT use the Height Limit Insert. Simply leave it unplugged and the system will always travel to the full extension. To limit the travel, follow the procedure below:



1. Using the IR Receiver, run the lift system to height limit position and stop it there.
2. With the lift system stopped, plug the Height Limit Insert into the available RJ45 port on the Control Box. This will set the height limit at this position for both the IR Remote (or 3<sup>rd</sup> party universal remote) and the IR Receiver.
3. If the height limit is set at the incorrect position, remove the Height Limit insert and repeat the procedure.

### To set your Travel Limit with RF Controls:

If you want the lift system to always go to its full extension, do NOT use the Height Limit Insert. Simply leave it unplugged and the system will always travel to the full extension. To limit the travel, follow the procedure below:

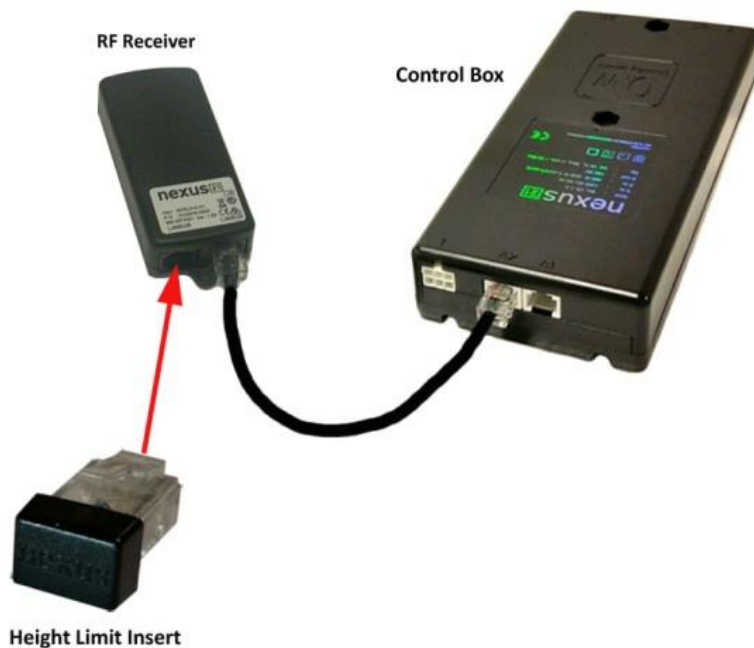

1. Using the Wired Backup Switch, run the lift system to the ideal height limit position and stop it there.
2. With the lift system stopped, plug the Height Limit Insert into the available RJ45 port on the RF Receiver. This will set the height limit at this position for both the RF Remote and Backup Switch.
3. If the height limit is set at the incorrect position, remove the Height Limit insert and repeat the procedure.

## Supplemental Page C: Connect the Lift to Home Control System

### Connecting the Nexus 21 Lift System to Other Control Systems

Use these instructions if you need to wire the Lift System directly to a Home Control System, like those made by Crestron, AMX, Control 4, RTI, etc. A common term for this method of integration is “connection by contact closure.”

#### Contents of Contact Closure Hardware Pack:

##### Step 1: Contact Closure Hardware Pack

This pack contains the following parts:

1 – *Contact Closure Cable*, RJ-45 to Relays

1 – *Height limit Insert*



Contact Closure Cable, RJ-45 to Relays



Height Limit Insert

##### Step 2: Connecting the Lift System to the Control System

Using the *Contact Closure Cable* to connect the three wires directly to the relays on your control module (see image below). Then connect the RJ-45 plug on the *Contact Closure Cable* to the Nexus 21 system, using either one of the two RJ-45 ports on the side of the Nexus 21 *Control Box*.

##### The colored wires function as follows:

**BLUE** = common (Pin 4 from RJ45) **GREEN** = Extend (Pin 5 from RJ45) **RED** = Retract (Pin 8 from RJ45)

##### Wire combinations for the relays:

The lift system uses two relays. One for “extend” and one for “retract.” The common wire runs between both relays, by using the **BLUE common wire**, together with a jumper wire you supply.

**Relay 1 Extend:** **BLUE** common wire with **GREEN** normally open.

**Relay 2 Retract:** **BLUE** common wire (use jumper) with **RED** normally open.



Close-up View of RJ-45 Pins



##### Step 3: Setting a Height Limit for the Lift System

Begin with the Height Limit Insert UNPLUGGED. Then send the “UP” command from your control system and run the Lift System up to your desired height. Once the Lift System is at the desired height, send the “DOWN” command to stop the lift at the point. Now PLUG the Height Limit Insert into the available RJ45 port on the Nexus 21 Control Box. The Lift will now remember the height and always stop at that point. To change, unplug the Height Limit Insert and repeat Step 3.

For technical support or to ask questions, call Nexus 21 Customer Service, toll-free at (866) 500-5438.

**How to Properly Install a Lid "Catch" with a Nexus 21 Lift System**

There are multiple ways to properly create a "catch" for the lid to rest on, when the lift is in the fully retracted position. Down below are a few examples.

Using the provided Lid Catch Brackets with (8) #10 x 3/4" THWS attach the brackets to each corner of the lid opening. This will provide a support point for the lid to rest on while the lift is in the fully retracted position, assuring the lid is flush with the rest of the cabinetry every time.

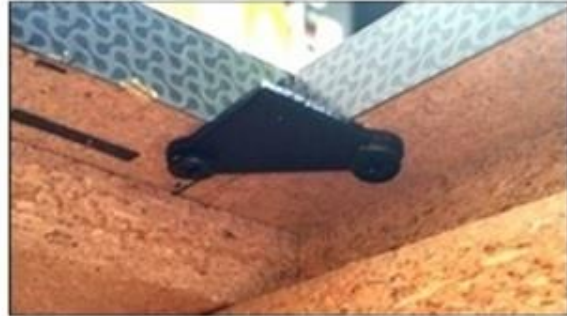

Here are a few other examples on how to create a "catch" or "lip" for the cabinet lid to rest upon.

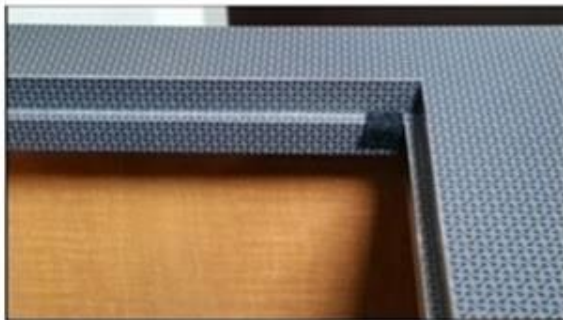



**nexus** 

**CONCEALMENT SYSTEMS**

866.500.5438